

SPECIFICATIONS

MODEL	# OF TEETH UPPER/ LOWER	(1) EXCAVATOR WEIGHT (APPROX.)		(2) ATTACHMENT WEIGHT (APPROX.)		(3) JAW OPENING (TIP TO TIP) (APPROX.)		(4) STANDARD BACK JAW WIDTH		STANDARD JAW DEPTH (TIP TO THROAT)	
		(lbs.)	(MTons)	(lbs.)	(Kg)	(in)	(mm)	(in)	(mm)	(in)	(mm)
CP 40	3 / 4	36-46,000	16-21	2,875	1,304	30	762	26	660	25	635
CP 60	3 / 4	46-65,000	21-29	3,000	1,361	36	914	29	737	27	686
CP 80	3 / 4	65-88,000	29-40	4,475	2,030	42	1,067	32.5	826	29	736
CP 100	3 / 4	88-111,000	40-50	6,150	2,790	48	1,219	33	838	35	889
CP 120	4 / 5	111-160,000	50-73	9,900	4,491	54	1,372	43.5	1,105	40	1,016

Custom Models may be available upon request. Consult a Stanley LaBounty representative for a review of your application requirements.

- (1) Excavator weight recommendation is based on standard excavator weights and boom and/or arm lengths. All applications must be approved by Stanley LaBounty prior to sale.
- (2) Weights, dimensions and operating specifications listed here are subject to change without notice. Where specifications are critical to your application, please consult Stanley LaBounty.
- (3) When used with the Rapid Tach II Quick coupler, the spec opening will be approximately 75% of listed spec opening in table above.
- (4) Jaw width can vary based on excavator stick configuration and linkage installation.

Note: Concrete thickness capacity varies greatly depending upon condition and configuration of the concrete. Consult a Stanley LaBounty representative for a review of your application requirements.

LaBounty[®] Concrete Pulverizers are designed for the quiet and controlled demolition and recycling of concrete bridge decks, walls, floor slabs, foundations, silos, culverts, encased beams, pre-cast materials, railings, etc. CP's excel in separating concrete from rebar, producing two recyclable products.

Features. Concrete Pulverizers feature custom lever arms to provide maximum crushing power, pin-on replaceable Swift Lock Teeth, heavy duty torque tubes which provide increased strength, main pivot consisting of spools, bearings and pins which when disassembled from the excavator remains together and can be built to work with the LaBounty Rapid Tach II coupling system (see reverse side for more information).

Ease of Installation. The CP uses existing excavator hydraulics-no additional circuits are required. A moveable front jaw, actuated by the excavator's bucket cylinder, closes into the stationary back jaw. The back jaw is pinned in place with a position arm which is pinned to a mounting pad welded on the lower surface of the excavator's stick.

Swift Lock Pin-On Replaceable Tooth System. Exclusively from LaBounty, this system allows quick and easy change-out of teeth, significantly reducing down time and costs associated with build up and hard facing.

CP Concrete Pulverizer Components

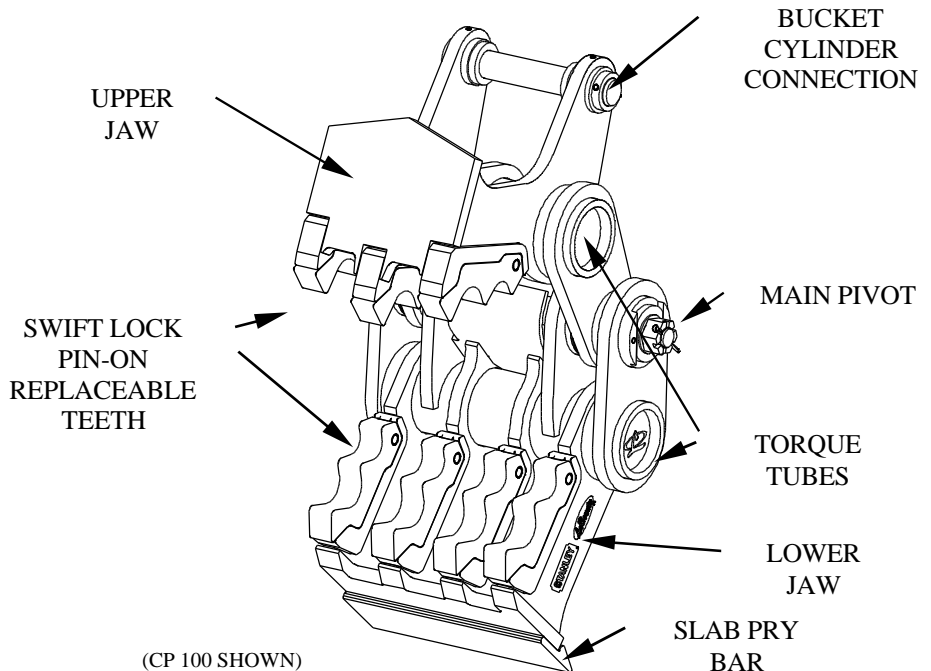

(CP 100 SHOWN)

ACCESSORIES AND WEAR PARTS

The items listed below are available for all Concrete Pulverizer Models

- Swift Lock, Pin-On Replaceable Teeth
- At-Factory Upgrade and Rebuilding Services
- Rapid Tach-II Quick Coupler Compatibility (must be indicated on initial order).

Multiple Machine Mount Capability. When an order is placed for a LaBounty Concrete Pulverizer, the unit will be manufactured specifically to pin on the excavator for which it was ordered. However, Concrete Pulverizers may be easily retrofitted to a variety of excavators within each weight class using Stanley LaBounty Installation Kits consisting of special bushings, spacers and pins. Please consult the Stanley LaBounty Inside Sales Department to determine compatibility and price of Installation Kits.

Concrete Pulverizer Operation. The LaBounty Concrete Pulverizer replaces the bucket of an excavator and operates with the same controls-no additional hydraulics are required. The bucket dump control operates the CP open and the bucket curl operates the CP close. Please see the illustration below.

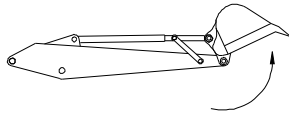

Bucket DUMP = CP OPEN

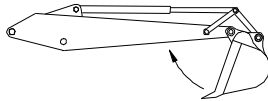

Bucket CURL = CP CLOSE

Concrete Pulverizer Operation w/ Rapid Tach-II Quick Coupler

Stanley LaBounty also offers its CP's to work with the Rapid Tach-II, pin capturing, manual, quick coupling system. In order to retain adequate performance (crushing force), the pin centers for the excavator/coupler mount have been spread. A subsequent loss of approximately 25% in the jaw opening of the CP can be expected. For buckets, a loss of up to 25° in bucket curl can be expected as well. For more information on the Rapid Tach Coupler and other attachments it can be used with, please refer to "RT Series" spec sheet, part number 511873.

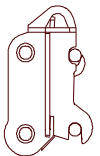

**RT-II
Coupler**



RT-II Mounting Pad

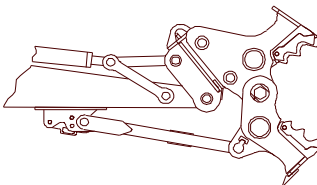

**CP with RT-II Coupler Attached –
Also shows RT Mounting Pad
Option**

Note: If a CP is to be ordered with a Rapid Tach - II quick coupler, it must be clearly noted on the purchase order. Otherwise, a direct pin-on version will be produced.

Other Rapid Tach-II / Attachment Combinations:

Besides buckets, hammers, compactors, etc., below are several other mechanical attachments offered by LaBounty that work in conjunction with the RT-II Rapid Tach coupling system. Please contact LaBounty for specific requirements:

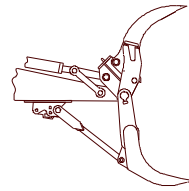

RT-II with HDR Grapple

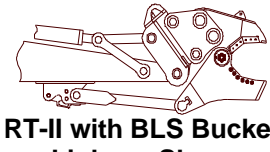

**RT-II with BLS Bucket
Linkage Shear**

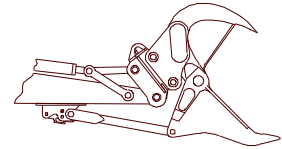

**RT-II with MWS
Wood Shear**

Warranty: The Concrete Pulverizers carry a limited warranty against defects in material and workmanship for 12 months or 1,500 hours from the date of purchase.

Stanley LaBounty reserves the right to repair or replace only those parts which prove to have been defective at the time of purchase.

Ask your Stanley LaBounty dealer to explain this warranty in detail.

Stanley LaBounty

1538 Highway 2
Two Harbors, MN 55616 USA
Tel: 218-834-2123 or 1-800-522-5059
Fax: 218-834-3879
E-Mail: labounty@stanleyworks.com

STANLEY®

LaBounty®