

NEW



COMPACT EXCAVATOR | 67C-1

Operating weight: 14903 lbs Net engine power: 51.5 HP



QUALITY TIME.

JCB'S NEW-GENERATION 67c ARE THE STRONGEST, MOST DURABLE, HIGH-PERFORMANCE 6-TON EXCAVATORS WE'VE EVER BUILT. THE CULMINATION OF 50 YEARS' EXPERTISE, THESE MACHINES HAVE BEEN DESIGNED AND DEVELOPED IN DIRECT RESPONSE TO OUR CUSTOMERS' STANDARDS.

Structural strength.

1 We've used a simplified H-frame construction and finite element analysis to design the ultimate heavy-duty structure. This chassis ensures that the 67c combines durability with confidence-inspiring stability.

2 Constructed using four plates, our clean and elegant arm design offers added structural strength.

At the dig end.

3 Maximum excavator arm protection is assured during all applications because these machines have a heavy-duty boom cylinder guard, with the option of arm and crowd ram guards too.

4 Our heavy-duty swing bracket with durable re-bushable pivots is built to last. We also use it to safely route all excavator hoses.

The boom and dipper is a fully welded unit, and made of high tensile strength steel. Internal baffle plates guarantee a long service life.



Superior componentry.

e The 67c benefits from truly premium components like JCB Diesel by Kohler and Perkins engines, Nachi and Bosch-Rexroth hydraulics, and Bridgestone tracks.

z By using high quality 16" rubber tracks with interlocking links, we know these machines will perform anywhere. Specify our 16"/22" steel tracks and you'll find they're pre-drilled to make it easier to attach rubber pads. You can also opt for dedicated Road Liner Pads (Bridgestone GeoGrip™), which allow you to replace individual segments in the event of damage.

e Hydraulic seals are the very latest O-ring face seal (ORFS) type, ensuring a robust connectivity between joints.

e When the cab door is folded back, it is well protected from damage during operation.



A GREAT PERFORMANCE.

WE'VE COMPREHENSIVELY IMPROVED VARIOUS KEY ASPECTS OF OUR 6-TON COMPACT EXCAVATORS. THE END RESULT IS THAT, IF YOU INVEST IN A JCB 67c, YOU'LL FIND THAT PERFORMANCE, VERSATILITY AND PRODUCTIVITY ARE PEERLESS.

Power and productivity.

1 The 67c has a JCB Diesel by Kohler common rail Stage IIIB/Tier 4 final-compliant engine. By using a Diesel Oxidation Catalyst, turbocharger and intercooler, we've increased power to 55 HP at just 2200rpm, and there's also 166 lbf ft of torque.

2 With a JCB 67c, tractive effort and the tracking speeds are class leading so high dozer capabilities and fast travel times are guaranteed. Our auto kickdown motors help to increase productivity and reduce operator fatigue by automatically adapting to changes in terrain.

Digging deeper.

3 The 67c offers superb spoil retention during truck loading courtesy of a huge 185° bucket rotation. For total versatility, you can specify your perfect arm length, ranging from 5'5" - 6'7".

Two arm options, 5'5" - 6'7", are available for the 67c giving increased performance and more versatility.

4 These machines produce arm breakout forces of up to 7000 lbf; combined with fast cycle times, this enables unrivalled productivity. By perfectly matching our boom and arm, we've created optimal dig end geometry, helping you to work and load in confined areas with ease.



2



3



4

Innovative hydraulics.

Expect improved flow sharing with our high quality closed center pump and valve. This setup provides smooth, precise and balanced operation during multi-functioning.

We understand that you may want to operate a wide array of versatility-enhancing attachments, so the 67c has standard high flow and optional low flow. These lines are proportionally operated via the electrics, with full adjustability for optimum attachment control.

The optional 4-way dozer can be angled right and left which, combined with the dozer float function makes levelling and backfilling work incredibly easy, even on inclines and uneven terrain.

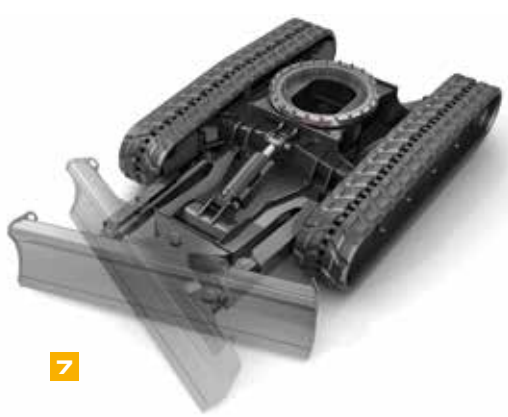

7

Versatility attached.

JCB offers a huge range of tailored attachments for these compact excavators so that you can enjoy ultimate operation and performance, as well as full warranty compliance.

Bucket pin geometry is identical to our world-leading 3CX backhoe loader so attachments are fully interchangeable between machines.

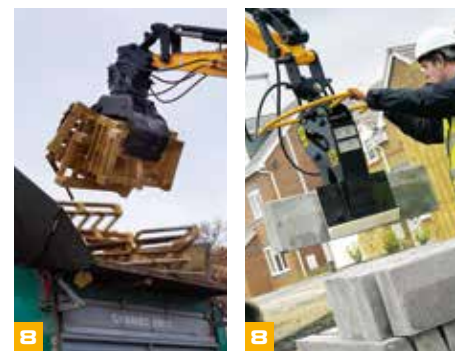

8

8



8



Redesigned dozer. In order to provide a winning balance of high performance and easy-clean low soil retention, we've completely overhauled our dozer profile and angle. Tapered lift points are located behind the blade edge for their protection.

5

MORE FOR YOUR MONEY.

ULTIMATELY, COST OF OWNERSHIP IS PERHAPS YOUR PRIMARY CONCERN AS A BUSINESS. SO YOU'LL BE PLEASED TO KNOW THAT THE JCB 67c HAS BEEN DESIGNED TO KEEP RUNNING COSTS AS LOW AS POSSIBLE.

Efficient engine design.

1 Because combustion in the 67c's Tier 4 Final JCB Diesel by Kohler engine is very clean, we haven't had to use a diesel particulate filter (DPF), which in turn reduces servicing, increases uptime and improves fuel efficiency.

Our Below Idle feature means that engine revs are reduced even further when the operator's armrest is raised. Fuel economy and noise levels are thus reduced.

2 You can program Auto Idle to activate after your 67c's controls have been inactive for any period between 2 and 30 seconds.

500 hour engine oil and filter intervals ensure machine downtime is minimized.



Economical in operation.

3 Tailor performance to match any application with two separate dig modes – ECO for maximum efficiency, and heavy for maximum productivity.

4 We've patented our near zero pressure return line circuit so you won't find it anywhere else. In short, it offers added fuel efficiency because the hydraulic pump can start work without having to overcome a very high pressure.



Damage can occur on site so we've fitted flat side glass windows to the 67c to minimise replacement costs.

This 6 metric ton excavator boasts load-sensing hydraulics that only consume power on demand so you save fuel for when you most need it.

COMFORTABLY SUPERIOR.

IN ORDER TO ENSURE MAXIMUM PRODUCTIVITY, YOUR OPERATORS NEED TO STAY FRESH AND ALERT ALL DAY LONG. FOR THIS REASON, WE'VE MADE THE JCB 67c ERGONOMIC AND COMFORTABLE TO OPERATE.

The working environment.

1 JCB's 6 metric ton excavator cab is now even more spacious, with storage galore, a phone tray, storage net and a cup holder. The whole area is accessed easily and safely via a large door.

2 A radio, 12V phone charger, powerful heater with window defroster and a high performing air conditioning system* with 9 vents completes the picture.

3 Fully adjustable suspension seating provides great operator comfort; our heated air suspension option, meanwhile, has independent adjustable positions for the ultimate in ergonomics. Our switches are intelligently and intuitively laid out around an informative colour LCD display with optional reversing camera.

* Air conditioning optional.



Smooth operation.

4 Rubber mounts have been deployed to isolate the hydraulic valve block from the chassis. This reduces in-cab noise and vibration, yet the valve block itself is still easy to access beneath a rear-opening hood.

5 Operators can be assured of smooth and precise grading control with our standard-fit ergonomic electro-hydraulic dozer control.

6 You can alternate quickly between single and double-acting auxiliary flow thanks to a convenient switch in the cab.

Switch between 10 different rates on the electro proportional high flow line for seamless operation of a huge variety of attachments.

7 To reduce vibration and noise – as well as provide the smoothest ride – the JCB 67c's short pitched tracks engage every tooth on the sprocket.



THE SAFE SIDE.

THE NEW JCB 67c COMPACT EXCAVATORS HAVE BEEN PAINSTAKINGLY DEVELOPED TO OFFER MAXIMUM PROTECTION TO OPERATORS, BYSTANDERS AND MACHINERY ALIKE.

Well protected.

- 1 JCB 67c cabs are fully ROPS and TOPS-compliant.
- 2 Standard boom and optional worklight guards offer great protection for vulnerable components during hazardous applications.
- 3 All hydraulic functions can be fully isolated with JCB's safety lever lock, thus preventing unintended movement.
- 4 With JCB's unique 2GO system, the hydraulics can only be operated in a safe lockable position via two separate inputs.



Safer by design.

5 The JCB 67c offers greater visibility than our outgoing 6-tonne models, thanks in part to a 70/30 front screen split that provides a clear view of the front right track for easy, safe trench digging and maneuvering.

6 Fit your machine with optional boom, dozer and arm hose burst check valves (HBCVs) to make lifting operations even safer.

7 Large track frame width and a low center of gravity helps to ensure that stability on both machines is best-in-class.



AT YOUR SERVICE.

IN ORDER TO MAXIMIZE PRODUCTIVITY, THE JCB 67c HAS LONG SERVICE INTERVALS. WHEN MAINTENANCE DOES NEED TO BE CARRIED OUT, WE'VE MADE SURE IT'S A QUICK AND EASY TASK.

Servicing and maintenance.

- 1 Graphite impregnated bronze bushes have enabled us to make greasing intervals at the dozer and dig ends a best-in-class 500 hours, saving you time and money.
- 2 For easier cleaning, material build-up is prevented on the 67c by a sealed idler tension unit, not to mention by an open frame undercarriage design with sloping track legs.
- 3 Select JCB's optional refuelling pump with its auto stop function and you'll experience reduced fuel spillage and increased safety.

The JCB 67c boasts the best SAE service rating on the market, with innovative features like a 30-degree tilting cab to make life easier. This feature requires no special tools, giving you fast access when servicing the machine.



Lifting the 67c is made easier by the tapered dozer lift points which are behind the edge of the blade; this also keeps them protected.

Easy maintenance.

- 4 Bodywork on our compact excavators are made exclusively of pressed steel with no plastic, making them strong and easy to repair.
- 5 Filling your fuel tank from ground level is easy with our wide opening steel hood and external diesel indicator.
- 6 These machines feature color-coded hydraulic hoses for easy identification. Dozer hoses are easy to replace because they terminate at the bulkhead.
- 7 You can remove the two-piece floor mat for easy cleaning. Meanwhile, a cast anti-slip tread plate provides safe access as well as long-term bodywork protection.

Auxiliary controls mounted on the joystick make the cab floor less cluttered, increasing leg room and storage space.

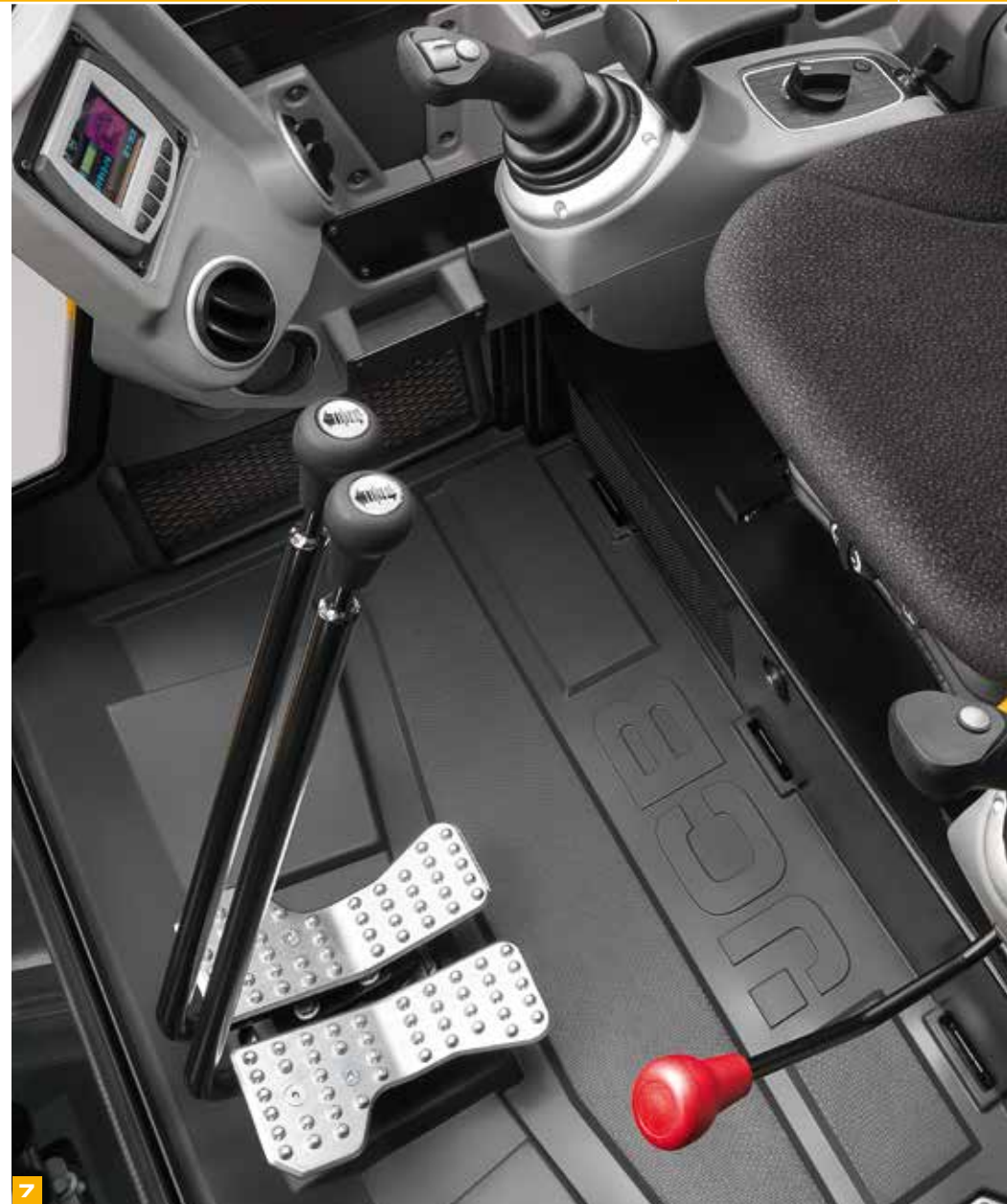

LIVELINK, WORK SMARTER.

LIVELINK IS AN INNOVATIVE SOFTWARE SYSTEM THAT LETS YOU MANAGE JCB MACHINES REMOTELY – ONLINE, BY EMAIL OR BY MOBILE PHONE. ACCESS EVERYTHING FROM MACHINE ALERTS TO FUEL REPORTS AND HISTORY INFORMATION, WITH ALL DATA STORED AT A SECURE CENTER.

Productivity and cost benefits

By providing information like idle time monitoring and machine fuel consumption, JCB Livelink helps reduce your fuel usage, saving money and improving productivity. Machine location information can help improve efficiency and perhaps even reduce insurance costs.



Maintenance benefits

Manage machine maintenance easily – accurate hours monitoring and service alerts improve maintenance planning, while real-time location data helps you manage your fleet. Critical machine alerts and maintenance history records are also available.



Security benefits

Livelink's real-time geofencing alerts tell you when machines move out of predetermined zones, and real-time curfew alerts inform you of unauthorised usage. Further benefits include real-time location information, advanced ECU matching (pairs Livelink with the immobiliser or ECU), and PIN code management (to remotely authorise usage – perfect for plant hire).



VALUE ADDED.

JCB'S WORLDWIDE CUSTOMER SUPPORT IS FIRST CLASS. WHATEVER YOU NEED AND WHEREVER YOU ARE, WE'LL BE AVAILABLE QUICKLY AND EFFICIENTLY TO HELP MAKE SURE YOUR MACHINERY IS PERFORMING TO ITS FULL POTENTIAL.



1

1 Our Technical Support Service provides instant access to factory expertise, day or night, while our Finance and Insurance teams are always on hand to provide fast, flexible, competitive quotes.

2 The global network of JCB Parts Centers is another model of efficiency; with 16 regional bases, we can deliver around 95% of all parts anywhere in the world within 24 hours. Our genuine JCB parts are designed to work in perfect harmony with your machine for optimum performance and productivity.

Note: JCB LIVELINK and JCB ASSETCARE may not be available in your region, so please check with your local dealer.



2

3 JCB Assetcare offers comprehensive extended warranties and service agreements, as well as service-only or repair and maintenance contracts. Irrespective of what you opt for, our maintenance teams around the world charge competitive labor rates, and offer non-obligation quotations as well as fast, efficient insurance repair work.



3

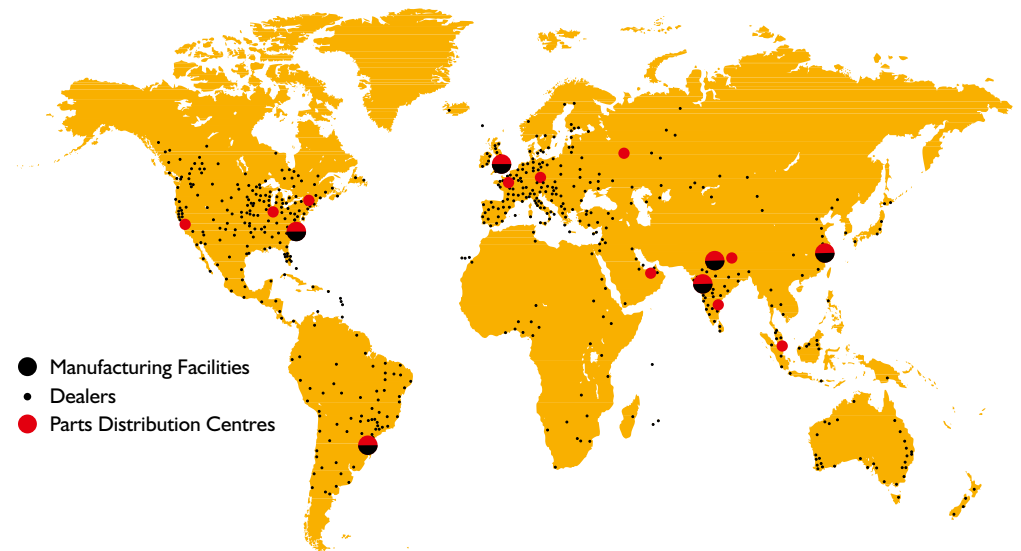

- Manufacturing Facilities
- Dealers
- Parts Distribution Centres

STATIC DIMENSIONS

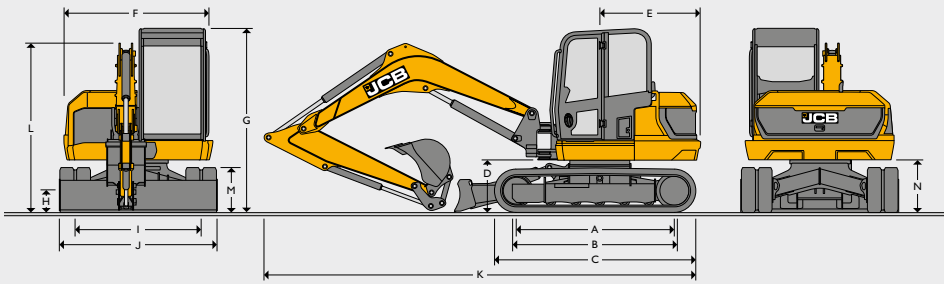

| Machine model | | 67C-1 |
|---------------|---------------------------------------|------------|
| A | Sprocket idler centres (rubber) | ft-in 6-6 |
| B | Track length on the ground | ft-in 6-6 |
| C | Undercarriage overall length (rubber) | ft-in 8-2 |
| | Undercarriage overall length (steel) | ft-in 8-2 |
| D | Kingpost clearance | ft-in 2-0 |
| E | Tailswing radius | ft-in 4-7 |
| F | Overall width of superstructure | ft-in 5-11 |
| G | Height over cab | ft-in 8-6 |
| H | Ground clearance | ft-in 0-9 |
| I | Track gauge | ft-in 6-11 |
| J | Width over tracks | ft-in 6-7 |
| K | Transport length - standard dipper | ft-in 18-4 |
| L | Transport height | ft-in 8-6 |
| M | Track height | ft-in 1-10 |
| N | Counterweight clearance | ft-in 2-1 |

ENGINE

| Machine model | | 67C-1 |
|---------------|--------------------|-----------------------|
| Model | | Tier 4 Final KDI 1903 |
| Fuel | | Diesel |
| Cooling | | Water cooled |
| Gross power | HP @ 2200 rpm | 55.0 |
| Net power | HP @ 2200 rpm | 51.5 |
| Gross torque | lbf.ft. @ 1400 rpm | 166 |
| Displacement | cubic inches | 116.13 |
| Gradeability | % | 30 |
| Starter motor | HP | 2.7 |
| Battery | volt/amps | 12V / 75ah |
| Alternator | amps | 80 (100) |

UNDERCARRIAGE

| Machine model | | 67C-1 |
|------------------------------------|-----|--------|
| No of top rollers | | 1 |
| No of bottom rollers | | 4 |
| Track width rubber (STD) | in | 16 |
| Track width steel | in | 16/22 |
| Ground bearing pressure STD tracks | psi | 6.0 |
| Ground clearance | in | 9 |
| Track tensioning | | Grease |
| Travel speed – Low | mph | 1.6 |
| Travel speed – High | mph | 2.9 |
| Tractive effort | lbf | 119 |

HYDRAULIC SYSTEM

| Machine model | | 67C-1 |
|---------------------------------|-----|--------|
| Pump | gpm | 19 |
| Nominal output (@ rated) | psi | 2089 |
| Excavator/track main relief | psi | 3626 |
| Slew main relief | psi | 3133 |
| Auxiliary hydraulic flow(low) | psi | 2756 |
| Auxiliary hydraulic flow(high) | psi | 2756 |
| Auxiliary hydraulic flow (Low) | gpm | 6.6 |
| Auxiliary hydraulic flow (High) | gpm | 23.8 |
| Hydraulic motors | | Piston |

WEIGHTS

| Machine model | | 67C-1 |
|---------------------------------------|-----|----------|
| Operating weight* (16" rubber tracks) | lbs | 14903 |
| Transport weight (46" rubber tracks) | lbs | 14738 |
| With FOGs guard – stage 1 | lbs | 31 |
| With FOGs guard – stage 2 | lbs | 132 |
| 16" steel tracks | lbs | 163 |
| 22" steel tracks | lbs | 298 |
| 16" Geo grip tracks | lbs | 187 |
| Ground bearing pressure 16" tracks | psi | 6.0 |
| Ground bearing pressure 22" tracks | psi | 4.4 |
| With wide dozer (7'1") | lbs | 24 |
| With 4 way dozer | lbs | 143 |
| With long arm (6'7") | lbs | Standard |
| With long arm (6'3") | lbs | N/A |
| With short arm (5'5") | lbs | 75 |

*Operating weight to ISO 6016 including cab, rubber tracks, standard dipper, 24" bucket, full tanks and a 165lb operator.
 *Shipping weight to ISO 6016 is mass of the base machine without an operator, with the fuel level at 10% of tank capacity.

OPERATOR ENVIRONMENT

| Machine model | 67C-1 | |
|---|-------|-----|
| Cab/canopy height | ft-in | 5-1 |
| Cab/canopy height with FOGS guard level 1 | ft-in | 5-5 |
| Cab/canopy height with FOGS guard level 2 | ft-in | 5-8 |
| Cab/canopy length | ft-in | 6-4 |
| Cab/canopy width | ft-in | 3-5 |
| Distance from seat base to roof | ft-in | 3-8 |
| Door aperture width | ft-in | 2-0 |

SERVICE CAPACITIES

| Machine model | 67C-1 | |
|------------------|-------|------|
| Fuel tank | gal | 21.9 |
| Engine coolant | gal | 2.6 |
| Engine oil | gal | 2.0 |
| Hydraulic system | gal | 24.4 |
| Hydraulic tank | gal | 15.1 |

STANDARD EQUIPMENT

Tilting cab, Fully glazed ROPS & TOPS certified cab with JCB Impact Protection front screen, Intermittent wiper with wash/wipe, Roof mounted worklights, 3 speed heater/demister with 9 adjustable air vents, Color LCD display, Digital clock, Internal lockable toolbox, Cup holder, Coat hook, 12v accessory socket, Interior light, Full audio/visual warning systems, Radio ready kit, Auto idle throttle, Below idle system, 2 digging modes (Eco & Heavy), ISO servo controls with electro-hydraulic dozer lever, Electro-proportional thumb controlled high flow double acting auxiliary, 10 selectable auxiliary flow rates, Joystick mounted hammer switch, Electronic single/double acting auxiliary changeover valve, Neutral start, Full control isolation, "2 go" hydraulic isolation, Midback suspension seat, 2 piece removable floor mat, Beacon ready kit, Two speed tracking, Auto-kickdown track motors, 16" short pitch rubber tracks, Double element air cleaner, Heavy-duty alternator, Heavy-duty battery, Hydraulic slew braking with disc type park brake, ORFS hydraulics, Color coded hydraulic hoses, Bushed swing bracket (67c), 500 hour dig end greasing intervals, Heavy-duty boom cylinder guard, Protected boom worklight, 6'7" dipper (67c), 2 position bucket tipping link - Speed & Power, Quick release auxiliary couplers, 100% steel bodywork.

OPTIONAL EQUIPMENT

Air-conditioning, Adjustable sunblind, FOPS guard stage 1, 16" or 22" steel tracks, 16" Geo Grip Road Liner tracks, Fan & chaff guards, Battery isolator, High back seat or deluxe heated high back air-suspension seat, Radio installation, Electro-proportional thumb controlled low flow auxiliary, Hose burst check valve lifting kit (dozer, boom & arm), Bucket-to-grab change over valve, Mechanical quickhitch, Hydraulic quickhitch, Hydraulic quickhitch ready pipework, General purpose digging buckets, Ditch/grading buckets, Hydraulic hammers, Rotating/strobe beacon, Travel alarm, Face fan, Toolkit, Greasegun & cartridge, Fire extinguisher, Exterior cab mounted mirrors, Interior mirror, Electric refuelling pump, JCB Immobiliser (Unique key or keypad system), Dozer float, Angled dozer blade (67c), Front screen guard, Short & long arm options, Thumb ready arm, LiveLink, Special paint options, Front pair of LED roof mounted worklights.



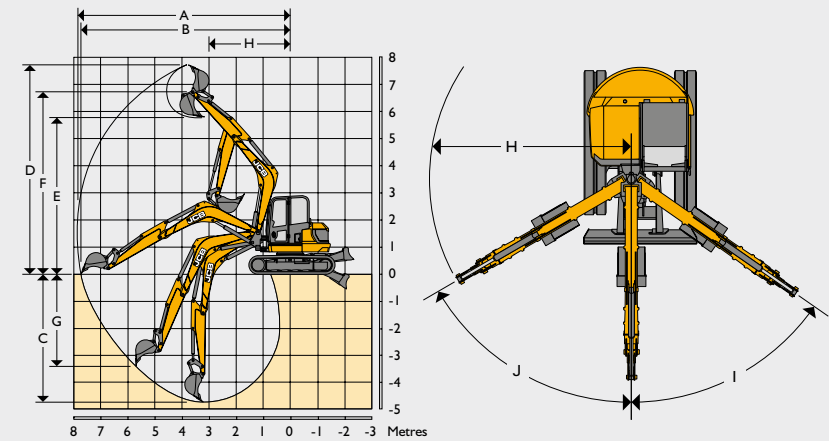











WORKING RANGE



| | 67C-1 | |
|--|---------|------------|
| Arm length | ft. in. | 5-5/6-7 |
| Boom length | ft. in. | 9-6 |
| A Max digging reach | ft. in. | 20-3/21-4 |
| B Max digging reach on ground | ft. in. | 20-2/21-2 |
| C Max digging depth - dozer up | ft. in. | 12-2/13-2 |
| Max digging depth - dozer down | ft. in. | 12-2/13-4 |
| D Max digging height | ft. in. | 19-3/20-0 |
| E Max dump height | ft. in. | 13-1/13-10 |
| F Max height to arm pivot pin | ft. in. | 16-2/16-11 |
| G Max vertical wall dig depth | ft. in. | 8-7/9-7 |
| H Min. front swing radius (no offset) | ft. in. | 8-5/8-7 |
| Min. front swing radius (fully offset) | ft. in. | 7-8/7-10 |
| I Boom swing left | degrees | 60 |
| J Boom swing right | degrees | 60 |
| Bucket rotation | degrees | 184.6 |
| Arm rotation | degrees | 118 |
| Bucket breakout force (power) | lbf | 10611 |
| Arm breakout force | lbf | 6992/6789 |
| Slew speed | rpm | 9.2 |















LIFT CAPACITIES – 16" RUBBER TRACK, 9'6" BOOM, 5'5" DIPPER, NO BUCKET

67C

| Load Point | 6' 7" | | | 9' 10" | | | 13' 1" | | | 16' 5" | | | Capacity at maximum reach | | | Distance |
|------------|---|---|---|---|---|---|---|---|---|---|---|---|---|---|---|----------|
| |  |  |  |  |  |  |  |  |  |  |  |  |  |  |  | |
| Height | Dozer Up | Dozer Down | Over Side | Dozer Up | Dozer Down | Over Side | Dozer Up | Dozer Down | Over Side | Dozer Up | Dozer Down | Over Side | Dozer Up | Dozer Down | Over Side | ft-in |
| ft-in | lb | lb | lb | lb | lb | lb | lb | lb | lb | lb | lb | lb | lb | lb | lb | ft-in |
| 13-1 | | | | | | | 3223 | 3148* | 2776 | | | | 2802 | 2802 | 2416 | 14-2 |
| 11-6 | | | | | | | 3225 | 3073* | 2778 | | | | 2460 | 2705 | 2125 | 15-5 |
| 9-10 | | | | | | | 3197 | 3192* | 2754 | | | | 2231 | 2542 | 1929 | 16-4 |
| 8-2 | | | | 4952 | 3871* | 4222 | 3150 | 3444* | 2712 | 2207 | 3269* | 1907 | 2083 | 2471 | 1801 | 17-0 |
| 6-7 | | | | 4793 | 4813* | 4083 | 3086 | 3790* | 2657 | 2189 | 3415* | 1892 | 1989 | 2498 | 1717 | 17-5 |
| 4-11 | | | | 4621 | 5855* | 3931 | 3018 | 4180* | 2595 | 2163 | 3549* | 1867 | 1933 | 2571 | 1671 | 17-7 |
| 3-3 | | | | 4469 | 6779* | 3799 | 2954 | 4561* | 2538 | 2134 | 3693* | 1843 | 1907 | 2593 | 1647 | 17-8 |
| 1-8 | | | | 4363 | 7416* | 3706 | 2897 | 4883* | 2487 | 2110 | 3812* | 1821 | 1914 | 2709 | 1653 | 17-7 |
| 0-0 | | | | 4301 | 7740* | 3653 | 2855 | 5104* | 2452 | 2092 | 3874* | 1803 | 1953 | 2751 | 1687 | 17-3 |
| 1-8 | 4892* | 3646* | 4449* | 4275 | 7796* | 3629 | 2831 | 5196* | 2429 | 2086 | 3816* | 1799 | 2035 | 3003 | 1755 | 16-9 |
| 3-3 | 7513* | 5600* | 6830* | 4273 | 7617* | 3627 | 2822 | 5132* | 2421 | | | | 2172 | 3254 | 1872 | 16-0 |
| 4-11 | 8472 | 7952* | 6975 | 4290 | 7198* | 3642 | 2835 | 4852* | 2432 | | | | 2385 | 3272 | 2055 | 15-0 |
| 6-7 | 8556 | 9912* | 7046 | 4334 | 6464* | 3680 | 2879 | 4158* | 2471 | | | | 2751 | 3746 | 2366 | 13-7 |
| 8-2 | 8684 | 8422* | 7154 | 4411 | 5190* | 3748 | | | | | | | 3428 | 3578 | 2937 | 11-9 |

LIFT CAPACITIES – 16" RUBBER TRACK, 9'6" BOOM, 6'7" DIPPER, NO BUCKET

67C

| Load Point | 6' 7" | | | 9' 10" | | | 13' 1" | | | 16' 5" | | | Capacity at maximum reach | | | Distance |
|------------|---|---|---|---|---|---|---|---|---|---|---|---|---|---|---|----------|
| |  |  |  |  |  |  |  |  |  |  |  |  |  |  |  | |
| Height | Dozer Up | Dozer Down | Over Side | Dozer Up | Dozer Down | Over Side | Dozer Up | Dozer Down | Over Side | Dozer Up | Dozer Down | Over Side | Dozer Up | Dozer Down | Over Side | ft-in |
| ft-in | lb | lb | lb | lb | lb | lb | lb | lb | lb | lb | lb | lb | lb | lb | lb | ft-in |
| 13-1 | | | | | | | 3303 | 2848* | 2848 | | | | 2972 | 2930 | 2564 | 13-11 |
| 11-6 | | | | | | | 3331 | 2641* | 2873 | | | | 2540 | 2736 | 2196 | 15-5 |
| 9-10 | | | | | | | 3322 | 2643* | 2864 | 2291 | 2732* | 1982 | 2264 | 2659 | 1960 | 16-6 |
| 8-2 | | | | | | | 3289 | 2793* | 2835 | 2293 | 2963* | 1984 | 2086 | 2676 | 1806 | 17-4 |
| 6-7 | | | | | | | 3236 | 3064* | 2789 | 2277 | 3031* | 1969 | 1958 | 2709 | 1695 | 17-11 |
| 4-11 | | | | 4943 | 4041* | 4213 | 3168 | 3430* | 2727 | 2249 | 3168* | 1944 | 1878 | 2747 | 1625 | 18-4 |
| 3-3 | | | | 4753 | 5113* | 4048 | 3091 | 3851* | 2659 | 2213 | 3342* | 1914 | 1825 | 2793 | 1579 | 18-7 |
| 1-8 | | | | 4570 | 6153* | 3887 | 3014 | 4279* | 2590 | 2178 | 3527* | 1883 | 1799 | 2846 | 1556 | 18-8 |
| 0-0 | | | | 4425 | 6978* | 3761 | 2943 | 4663* | 2529 | 2145 | 3697* | 1852 | 1803 | 2908 | 1559 | 18-6 |
| 1-8 | | | | 4330 | 7507* | 3677 | 2888 | 4963* | 2480 | 2119 | 3827* | 1828 | 1834 | 2974 | 1585 | 18-3 |
| 3-3 | | | | 4277 | 7756* | 3629 | 2848 | 5148* | 2445 | 2101 | 3885* | 1812 | 1896 | 3139 | 1638 | 17-9 |
| 4-11 | 7264* | 5415* | 6605* | 4255 | 7758* | 3611 | 2829 | 5199* | 2427 | 2097 | 3821* | 1808 | 2000 | 3455 | 1726 | 17-0 |
| 6-7 | 8333 | 7304* | 6859 | 4259 | 7527* | 3616 | 2826 | 5082* | 2425 | | | | 2163 | 3649 | 1865 | 16-1 |
| 8-2 | 8411 | 9760* | 6923 | 4288 | 7028* | 3640 | 2848 | 4722* | 2445 | | | | 2421 | 3713 | 2086 | 14-11 |
| -2.5 | 8523 | 10346* | 7017 | 4345 | 6162* | 3691 | 2908 | 3865* | 2498 | | | | 2873 | 3761 | 2467 | 13-3 |
| -3.0 | | | | 4451 | 4603* | 3783 | | | | | | | 3810 | 3677 | 3254 | 11-0 |

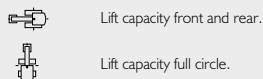

- Notes:**
1. Lifting capacities are based on ISO 10567, that is: 75% of minimum tipping load or 87% of hydraulic lift capacity, whichever is the less. Lifting capacities marked* are based on hydraulic capacity.
 2. Lift capacities assume that the machine is on firm level ground and equipped with an approved lifting point.
 3. A bucket must be fitted when lifting, the weight of this bucket must be deducted from the above lift capacities.
 4. Lift capacities may be limited by local regulations. Please refer to your dealer.





ONE COMPANY, OVER 300 MACHINES.

Compact Excavator 67c-1

Operating weight: 14903 lbs Net engine power: 51.5 HP

JCB North American – Headquarters

Savannah, 2000 Bamford Blvd., Savannah, Georgia, 31322 Tel: (912) 447-2000

Download the very latest information on this product range at www.jcb.com

JCB inc. All rights reserved. No part of this publication may be reproduced, stored in a retrieval system, or transmitted in any form or by any other means, electronic, mechanical, photocopying or otherwise, without prior permission from JCB inc. All references in this publication to operating weights, sizes, capacities and other performance measurements are provided for guidance only and may vary dependant upon the exact specification of machine. They should not therefore be relied upon in relation to suitability for a particular application. Guidance and advice should always be sought from your JCB Dealer. JCB reserves the right to change specifications without notice. Illustrations and specifications shown may include optional equipment and accessories. The JCB logo is a registered trademark of J C Bamford Excavators Ltd.

Your nearest JCB Dealer

9999/5861 en-US 11/14 Issue 1

 /JCBNA
  /JCBNA
  /JCBNORTHAMERICA

