



HYDRAULIC EXCAVATOR | JS220LC

Engine power: 173hp (129kW) Bucket capacity: 14.1 – 42ft³ Operating weight: 48290 – 49582lb



STRENGTH INSIDE AND OUT.

BEFORE YOU BUY AN EXCAVATOR, YOU NEED TO KNOW IT'S GOING TO BE TOUGH ENOUGH TO PERFORM ANY JOB YOU ASK OF IT. FORTUNATELY, WITH A JCB JS220, STRENGTH AND DURABILITY COME STANDARD.

We use Finite Element Analysis with extensive rig and endurance testing to make key components last longer.



Boom and arm.

- 1 A new reinforced boom and arm is made of high tensile strength steel, with three piece wrapper plates and cast ends for strength and durability.
- 2 Our advanced manufacturing and assembly processes produce high precision and quality assembled components.

Componentry.

- 3 Our engine technology is tried and proven; we've built 200,000 EcoMAX units since 2004. To ensure similar longevity, the JS220's EcoMAX engines have been tested for 110,000 hours in 70 different machines across the toughest applications and environments.
- 4 JCB JS220s boast the best components in the industry, including Berco undercarriage, Kawasaki pumps, Kayaba valve blocks and JCB EcoMAX engines.



Structural strength.

- 5 The high-strength undercarriage of a JCB JS220 uses a fully-welded X frame construction for long-term durability even in the most demanding applications.
- 6 A closed box section revolving frame increases strength and reduces stress. It's also highly resistant to impact damage.
- 7 The high-strength rigid upper frame provides maximum durability and support.
- 8 Our stiff, durable door design gives great strength and rigidity.



The JCB JS220 turret is welded to both the upper and lower undercarriage frame.



5

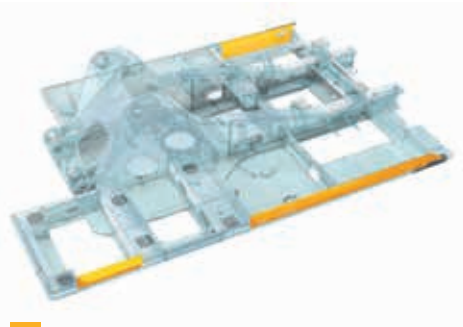

6



7



8

MAXIMUM PRODUCTIVITY, MINIMUM SPEND.

SAVING MONEY AND TIME IS MORE IMPORTANT THAN EVER, SO WE'VE MADE SURE THE NEW JCB JS220'S COMPONENTRY – INCLUDING THE ECOMAX TIER 4 FINAL ENGINE – WORKS IN PERFECT HARMONY. IN TURN, YOU GET A MACHINE THAT'S AS EFFICIENT AND PRODUCTIVE AS POSSIBLE.

Versed in versatility.

1 JCB's quickhitch system makes attachment changing fast and easy, and is purpose-designed for the JS range.

For ultra versatility, JCB offers a full list of auxiliary pipework options including hammer, auxiliary, and low flow. A long reach boom and arm is also available for specific applications.

2 The JS220 is a hugely versatile machine that's made all the more so by a big range of attachments, enabling you to carry out a wide range of tasks.



1



2



Upping output.

- 3 Simultaneous tracking and excavating is smooth and fast with an intuitive multifunction operation.
- 4 A JCB JS220 has a solid, stable work platform for fast cycle times.
- 5 With a massive 33,510lb bucket tearout and fast cycle times, the JS220 is extremely productive in all applications.
- 6 JCB's innovative hydraulic regeneration system means oil is recycled across the cylinders for faster cycle times and reduced fuel consumption.

The efficient excavator.

- 7 JCB's new EcoMAX Tier 4 Final engine uses up to 6% less fuel than our Tier 4i units, saving you money. This is partly due to the fact that EcoMAX produces high torque at just 1500 – 1600rpm, making for improved fuel-efficient matching of the hydraulics.
- 8 To reduce noise pollution from unnecessary air flow, the engine-driven cooling fan has a proportional control system, maintaining optimum fan speed.
- 9 The JS220 variable power bands allow you to tailor performance – and therefore economy – to specific tasks.



To save fuel, JCB Auto-Idle technology automatically reduces engine speed when hydraulics aren't in use. To optimize fuel efficiency still further, the JS220 benefits from advanced hydraulic technology, including optimized hydraulic pump settings, advanced spool design, and cutting edge electronic management software.

A JCB JS220 has cushioned boom and arm ends to prevent shock loadings, protect your machine and increase operator comfort.



A COMFORTABLE FAVORITE.

JCB EXCAVATORS ARE DESIGNED AROUND THE OPERATOR. THAT'S GOOD FOR THEM BUT EVEN BETTER FOR YOU; AFTER ALL, GREAT COMFORT AND EASE OF USE EQUALS GREAT PRODUCTIVITY.



A large laminated glass roof window gives the JS220 optimum visibility for working at height.

Light, intuitive and smooth controls improve comfort and productivity. The JS220 joystick-mounted power boost button gives extra hydraulic power fast.

A balanced slew and electronic/hydraulic controlled slew braking give speed and precision.

Excellent visibility.

1 A 70/30 front screen split gives JCB JS220 excellent front visibility. A clear view of the front right track provides easy, safe trench digging and maneuvering.

2 An innovative low-level hood provides excellent rearward visibility.

Comfortably in control.

3 The 7" color monitor multi-function display is easy to read in all light conditions, provides instant operational information, and has a customizable home screen.

The JS220 Tool Select feature can set up auxiliary hydraulic circuits quickly and accurately to match flow and pressure requirements of any attachment.

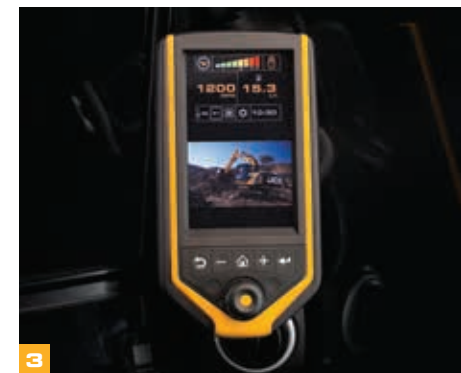



5

The working environment.

4 The JS220 creates a quieter working environment inside and out. Because we've reduced noise levels to 72dB(A) inside and 103dB(A) outside, you can use the machine at any location, anytime.

JCB JS220 cabs use 6 viscous rubber mounts to minimize noise and vibration.

The positive pressure cab keeps out dirt and dust.

5 JCB's climate control option offers a precisely controlled cab temperature with fresh or recirculated air. Defrosting functions keep the front window clear.

6 There's a spacious luggage tray behind the operator's seat with an independent 12v power supply that could be used for a cold storage box.

7 A large floor area with large high grip pedals gives easy and precise tracking.



6

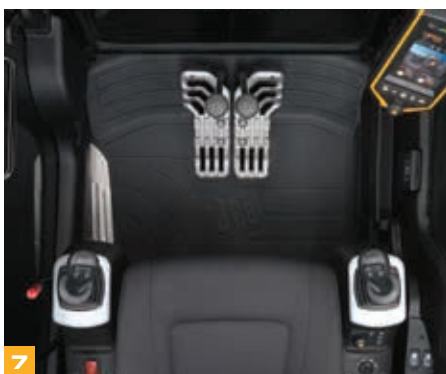

7



The JS220 cab and controls are independently adjustable so that it's easy to find the perfect operating position.



4

We offer tailored seating options to suit many different applications.

LESS SERVICING, MORE SERVICE.

WE'VE DESIGNED THE JCB JS220 TO BE LOW MAINTENANCE AND EASILY SERVICEABLE. THIS MAKES IT AFFORDABLE, EFFICIENT AND HIGHLY PRODUCTIVE, HELPING YOU GET THE BEST SERVICE FROM YOUR MACHINE.



By using graphite impregnated bronze bushes, we've reduced the JS220 boom and arm greasing intervals to 1000 hours for normal applications.

JCB JS220 grease points are centralized for safe and easy access to high level pivots.



1

Easy does it.

- 1 The air filter on a JS220 is easily accessible, and a double-element construction simplifies cleaning.
- 2 The filters on a JS220 (engine oil, hydraulic oil and fuel) are centrally located for fast, easy servicing.
- 3 The engine coolant radiator and hydraulic oil cooler are mounted side by side with the Charge air cooler placed in front. This allows maximum cooling efficiency to take place.

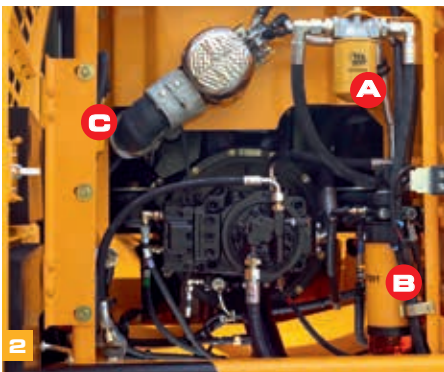

(A) Hydraulics oil filters (B) Fuel filters (C) Engine Oil Filter

	SERVICE INTERVALS
Engine oil and oil filter	Every 500 hours
Hydraulic oil filter	Every 1 000 hours
Hydraulic oil	Every 5000 hours



3

Here to help.

4 The JCB EcoMax T4F engine does not require the use of a DPF and so removes the cost of any expensive servicing or repairs to the units.

5 We've eliminated the need for a visibowl style pre-cleaner on the JS220 with our new scavenger filtration system. This uses suction from the cooling fan to remove heavier particles from the induction system.

6 Our innovative recalibration option allows EcoMAX to run on lower grade fuels. This means the JS220 can be resold across different territories, which improves residuals.

7 JCB's In-Cab Monitor checks engine oil levels, coolant, and system errors on start-up.

8 JCB meets the latest EPA Tier 4 Final emissions legislation without the use of a DPF (Diesel Particulate Filter). The Diesel Exhaust Fluid (DEF) tank can be easily accessed via the new revised step layout on the upper structure.



JCB JS220 hoods open and close easily with gas-assisted cylinders, and the service bays are large and wide for good access.



THE SAFE CHOICE.

ON-SITE SAFETY IS CRUCIAL, SO WE'VE DESIGNED THE JCB JS220 TO INCORPORATE AS MANY CUTTING EDGE SAFEGUARDS AS POSSIBLE. IN SHORT, YOUR OPERATORS ARE IN SAFE HANDS.

We've fitted as standard a bulk head heat shield between the pumps and the engine to guard against heat and noise.



1 The JS220 hood opens front-to-rear for easy and safe engine service access.

2 For extra peace of mind, JCB JS220 cabs are available with an integral Rollover Protection Structure (ROPS). It's also easy to fit JCB's Falling Objects Protection Structure (FOPS), thanks to standard fitment mounting brackets.

3 JCB's Safety Level Lock fully isolates hydraulic functions to avoid unintended movements. Our 2GO system means a JCB JS220 can only be started in a safe locked position via two separate inputs.

4 JCB JS220s have a large glass area and low hood line for superb visibility.

5 A JCB JS220's steps and platforms have anti-slip punched steel plates for optimum grip, even in wet or icy conditions. Bolt-on plates have recessed bolts to reduce trip hazards.

6 Our standard rear and optional side view cameras display uninterrupted rearwards and sideways views on the smart controller display.



7 Your JS220 is equipped with a full set of side and rear view mirrors for all round visibility and safety compliance.

8 There's no need to climb onto the JS220 to check oil levels; all routine servicing can be done from ground level.

9 Optional safety rails protect operators from falls when they're on the upper structure of the JS220.

The JS220's optional beacons can improve on-site safety still further.

10 Choose LED work lights for an even better field of vision on the JS220.



7



8



9



10

LIVELINK, WORK SMARTER.

LIVELINK IS AN INNOVATIVE SOFTWARE SYSTEM THAT LETS YOU MANAGE JCB MACHINES REMOTELY – ONLINE, BY EMAIL OR BY MOBILE PHONE. ACCESS EVERYTHING FROM MACHINE ALERTS TO FUEL REPORTS AND HISTORY INFORMATION, WITH ALL DATA STORED AT A SECURE CENTER.

Productivity and cost benefits.

By providing information like idle time monitoring and machine fuel consumption, JCB LiveLink helps reduce your fuel usage, saving money and improving productivity. Machine location information can help improve efficiency and perhaps even reduce insurance costs.



Maintenance benefits.

Manage machine maintenance easily – accurate hours monitoring and service alerts improve maintenance planning, while real-time location data helps you manage your fleet. Critical machine alerts and maintenance history records are also available.



Security benefits.

LiveLink's real-time geofencing alerts tell you when machines move out of predetermined zones, and real-time curfew alerts inform you of unauthorized usage. Further benefits include real-time location information, advanced ECU matching (pairs LiveLink with the immobilizer or ECU).



VALUE ADDED.

JCB'S WORLDWIDE CUSTOMER SUPPORT IS FIRST CLASS. WHATEVER YOU NEED AND WHEREVER YOU ARE, WE'LL BE AVAILABLE QUICKLY AND EFFICIENTLY TO HELP MAKE SURE YOUR MACHINERY IS PERFORMING TO ITS FULL POTENTIAL.



1 Our Technical Support Service provides instant access to factory expertise, day or night, while our Finance and Insurance teams are always on hand to provide fast, flexible, competitive quotes.

2 The global network of JCB Parts Centers is another model of efficiency; with 16 regional bases, we can deliver around 95% of all parts anywhere in the world within 24 hours. Our genuine JCB parts are designed to work in perfect harmony with your machine for optimum performance and productivity.



3 JCB Assetcare offers comprehensive extended warranties and service agreements, as well as service-only or repair and maintenance contracts. Irrespective of what you opt for, our maintenance teams around the world charge competitive labor rates, and offer non-obligation quotations as well as fast, efficient insurance repair work.

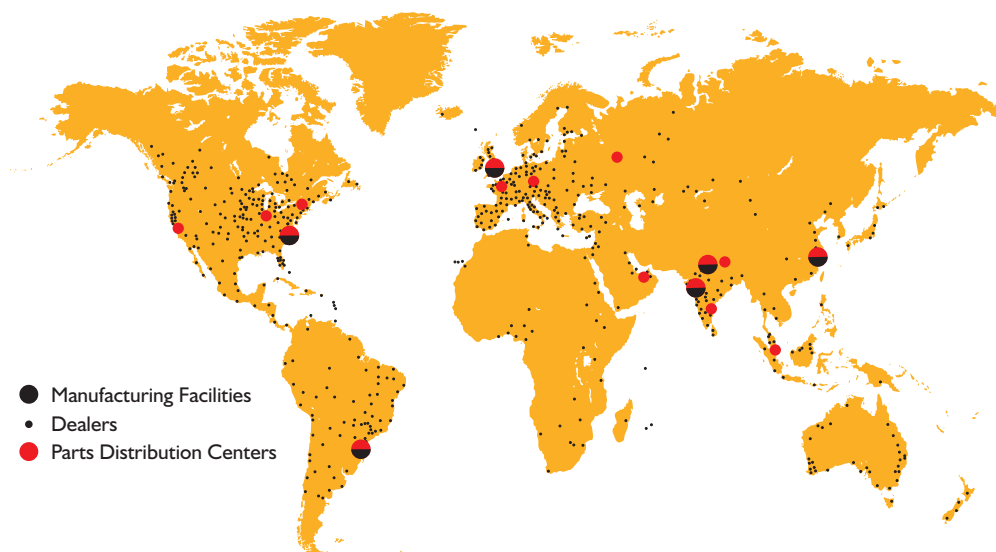

Note: JCB LIVELINK and JCB ASSETCARE may not be available in your region, so please check with your local dealer.

STATIC DIMENSIONS

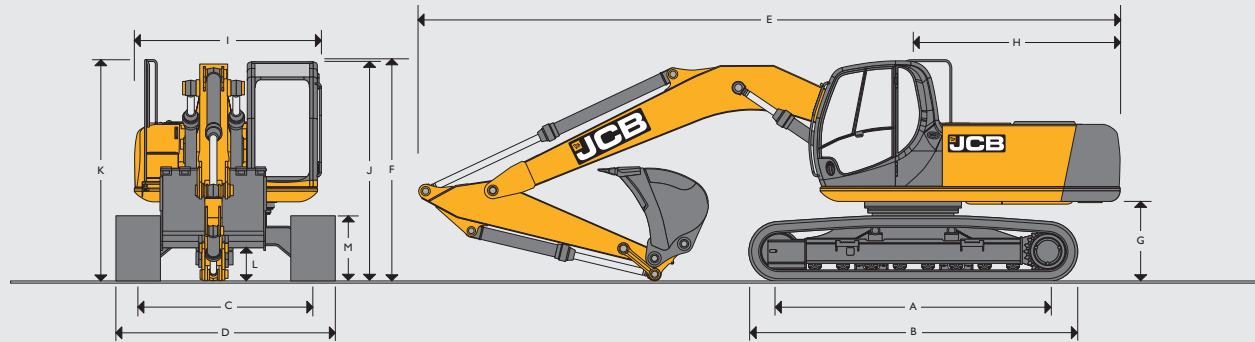

STATIC DIMENSIONS

A	Track length on ground	ft-in (mm)	12-0 (3660)
B	Undercarriage overall length	ft-in (mm)	14-8 (4460)
C	Track gauge	ft-in (mm)	7-10 (2390)
D	Width over tracks (24" trackshoes)	ft-in (mm)	9-10 (2990)
D	Width over tracks (28" trackshoes)	ft-in (mm)	10-2 (3090)
D	Width over tracks (31" trackshoes)	ft-in (mm)	10-6 (3190)
D	Width over tracks (35" trackshoes)	ft-in (mm)	10-10 (3290)
G	Counterweight clearance	ft-in (mm)	3-5 (1046)
H	Tailswing radius	ft-in (mm)	9-3 (2825)
I	Width of superstructure – upper	ft-in (mm)	8-4 (2548)
J	Height over cab	ft-in (mm)	9-10 (2996)
K	Height over grab rail	ft-in (mm)	10-0 (3037)
L	Ground clearance	ft-in (mm)	1-8 (503)
M	Track height	ft-in (mm)	2-11 (885)

Monoboomb 18-8 (5.7m)

Dipper lengths		6-3	7-10	9-10	
E	Transport length with Monoboomb	ft-in (mm)	31-5 (9584)	31-5 (9584)	31-5 (9584)
F	Transport height with Monoboomb	ft-in (mm)	10-5 (3179)	10-7 (3232)	10-5 (3179)

BUCKET AND ARM COMBINATION - MONOBOOMB

Arm length	6'3" (1.9m)	7'10" (2.4m)	9'10" (3.0m)
GP Bucket 600mm	☐	☐	☐
GP Bucket 750mm	☐	☐	☐
GP Bucket 900mm	☐	☐	☐
GP Bucket 1100mm	☐	☐	☐
GP Bucket 1200mm	☐	■	■
GP Bucket 1350mm	■	■	●
GP Bucket 1500mm	■	●	✘
Arm length	6'3" (1.9m)	7'10" (2.4m)	9'10" (3.0m)
HD Bucket 600mm	☐	☐	☐
HD Bucket 750mm	☐	☐	☐
HD Bucket 900mm	☐	☐	☐
HD Bucket 1100mm	☐	☐	☐
HD Bucket 1200mm	☐	■	●
HD Bucket 1350mm	■	●	✘
HD Bucket 1500mm	●	●	✘

☐ = Suitable for general excavating (materials up to 112.4 lb/ft³)

■ = Suitable for light excavating (materials up to 93.6 lb/ft³)

● = Suitable for grading and loading (materials up to 74.9 lb/ft³)

✘ = Not warranted

* Bucket capacity recommendations calculated for Monoboomb only.

WEIGHTS AND GROUND BEARING PRESSURES

Figures include 40.3ft³, 1676 lb bucket, operator, full fuel tank and 7'10" arm.

		24in (600mm) shoes	28in (700mm) shoes	31in (800mm) shoes	35in (900mm) shoes
JS220 LC MONO					
Machine weight	lb (kg)	48290 (21904)	48881 (22172)	49472 (22440)	49582 (22490)
Ground bearing pressure	psi (bar)	(6.7) 0.46	(5.8) 0.40	(5.2) 0.36	4.6 (0.32)

ENGINE

Model	JCB EcoMAX Tier 4 Final.
Type	4-stroke, 4-cylinder in-line, direct injection, turbocharged diesel.
Nett power (ISO 3046-1NF)	173hp (129kW)
Piston displacement	293 in ³ .
Injection	Electronic injection.
Air filtration	Dry element with in cab warning indicator.
Cooling	Water cooled via large capacity radiator.
Starter motor	24 volt – 6hp
Batteries	2 x 12 volt Heavy-duty.
Alternator	24 Volt – 55 amps.
Refuelling pump	Electric type.

UNDERCARRIAGE

Carriage options	LC – Long Carriage.
Recovery point	Front and rear.
Track type	Sealed and greased.
Track shoe options	24in (600mm), 28in (700mm), 31in (800mm), 36in (900mm).
Upper and lower rollers	Heat treated, sealed and lubricated.
Track adjustment	Grease cylinder type.
Track idler	Sealed and lubricated, with spring cushioned recoil.
No. of track guides	2 per side
No. of lower rollers	8 per side
No. of upper rollers	2 per side
No. of track shoes	49 per side

TRACK DRIVE

Type	Fully hydrostatic, three speed with autoshift between high and medium speed.
Travel motors	Variable swash axial piston type, fully guarded within undercarriage frame.
Final drive	Planetary reduction, bolt-on sprockets.
Service brake	Hydraulic counter balance valve to prevent overspeeding on gradients.
Park brake	Disc type, spring applied, automatic hydraulic release
Gradeability	70% (35 deg) continuous.
Travel speed	High – 3.4mph (5.6km/h). Mid – 2.1mph (3.3km/h).
Tractive effort	43144lbf (191.9kNm).

SERVICE CAPACITIES

Fuel tank	gal (liters)	62 (235)
Radiator	gal (liters)	8.5 (31.5)
Engine oil	gal (liters)	5.4 (20.4)
Swing drive	gal (liters)	1.3 (5)
Hydraulic tank	gal (liters)	31.7 (120)
Final drive (each side)	gal (liters)	1.2 (4.7)
DEF tank	gal (liters)	17.7 (65)

SWING SYSTEM

Swing motor	Axial piston.
Swing brake	Hydraulic braking plus automatic spring applied disc type parking brake.
Final drive	Planetary reduction.
Swing speed	12.9rpm.
Swing gear	Large diameter, internally toothed fully sealed grease bath lubricated.
Swing lock	Switchable brake in cab.

HYDRAULIC SYSTEM

Pumps	
Main pumps	2 variable displacement axial piston type.
Maximum flow	2 x 60gpm (2 x 228 lpm)
Servo pump	Gear type.
Maximum flow	4.8gpm (18 lpm)

Control valve

A combined four and five spool control valve with auxiliary service spool as standard.

Relief valve settings

Boom/Arm/Bucket	4975psi (343bar)
With power boost	5395psi (372bar)
Swing circuit	4046psi (279bar)
Travel circuit	4975psi (343bar)
Pilot control	58 psi (40bar)

Filtration

In tank	150 micron, suction strainer.
Main return line	10 micron glass fibre.
Pilot line	10 micron, paper element.
Hydraulic hammer return	10 micron, reinforced microform element.







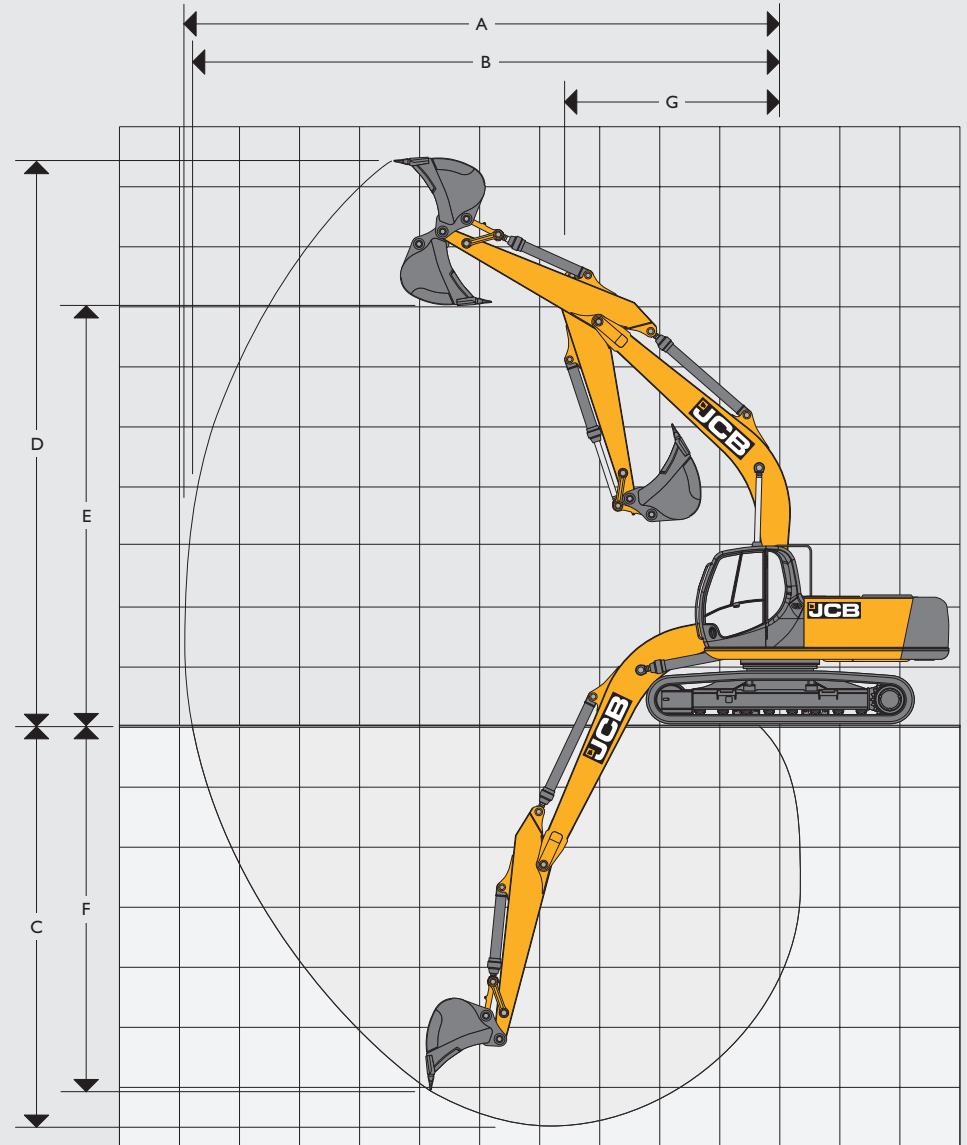



WORKING RANGE

Boom length 18'8" (5.7m)











Arm length		6'3" (1.9m)	7'10" (2.4m)	9'10" (3.0m)
A	Maximum digging reach	ft-in (mm) 28-7 (8720)	30-7 (9320)	32-4 (9850)
B	Maximum digging reach (on ground)	ft-in (mm) 27-11 (8520)	30-0 (9150)	31-8 (9650)
C	Maximum digging depth	ft-in (mm) 18-1 (5520)	19-7 (5980)	22-0 (6700)
D	Maximum digging height	ft-in (mm) 28-5 (8670)	29-6 (8990)	30-3 (9210)
E	Maximum dumping height	ft-in (mm) 20-4 (6190)	21-2 (6450)	21-10 (6660)
F	Maximum vertical wall cut depth	ft-in (mm) 17-0 (5182)	17-3 (5273)	19-1 (5820)
G	Minimum swing radius	ft-in (mm) 12-4 (3760)	12-5 (3780)	12-0 (3650)
	Bucket rotation	deg 183°	183°	183°
	Arm breakout force (ISO 6015)	lbf (kgf) 29652 (13450)	25485 (11560)	21142 (9590)
	Arm breakout force with boost (ISO 6015)	lbf (kgf) 32210 (14610)	27668 (12550)	22950 (10410)
	Bucket breakout force (ISO 6015)	lbf (kgf) 32077 (14550)	32077 (14550)	32077 (14550)
	Bucket breakout force with boost (ISO 6015)	lbf (kgf) 34833 (15800)	34833 (15800)	34833 (15800)













LIFT CAPACITIES – ARM LENGTH: 6'3" (1.9M) MONOBOOM 18'8" (5.7M), TRACKSHOES: 28" (700MM), NO BUCKET. JS220 LC MONO

Reach	9'10" (3m)		14'9" (4.5m)		19'8" (6m)		24'7" (7.5m)		Capacity at Max Reach		ft-in (mm)
											
Load Point Ht.	lb (kg)	lb (kg)	lb (kg)	lb (kg)	lb (kg)	lb (kg)	lb (kg)	lb (kg)	lb (kg)	lb (kg)	
19'8" (6.0m)					13735 (6230)*	12655 (5740)			13823 (6270)*	12037 (5460)	20-4 (6191)
14'9" (4.5m)			17284 (7840)*	17284 (7840)*	14506 (6580)*	12412 (5630)			13889 (6300)*	9855 (4470)	22-11 (6983)
9'10" (3.0m)			21429 (9720)*	17946 (8140)	16182 (7340)*	11971 (5430)			13338 (6050)	8885 (4030)	24-3 (7390)
4'11" (1.5m)					17769 (8060)*	11574 (5250)			12919 (5860)	8576 (3890)	24-6 (7477)
0			25199 (11430)*	16887 (7660)	17593 (7980)	11354 (5150)			13382 (6070)	8841 (4010)	23-10 (7255)
-4'11" (-1.5m)			24251 (11000)*	16932 (7680)	17571 (7970)	11332 (5140)			15036 (6820)	9855 (4470)	22-0 (6693)
-9'10" (-3.0m)	28373 (12870)*	28373 (12870)*	21297 (9660)*	17218 (7810)					16336 (7410)*	12456 (5650)	18-8 (5690)

LIFT CAPACITIES – ARM LENGTH: 7'10" (2.4M), MONOBOOM 18'8" (5.7M), TRACKSHOES: 28" (700MM), NO BUCKET. JS220 LC MONO

Reach	9'10" (3m)		14'9" (4.5m)		19'8" (6m)		24'7" (7.5m)		Capacity at Max Reach		ft-in (mm)
											
Load Point Ht.	lb (kg)	lb (kg)	lb (kg)	lb (kg)	lb (kg)	lb (kg)	lb (kg)	lb (kg)	lb (kg)	lb (kg)	
19'8" (6.0m)					12412 (5630)*	12412 (5630)*			11662 (5290)*	10560 (4790)	22-2 (6755)
14'9" (4.5m)			15719 (7130)*	15719 (7130)*	13470 (6110)*	12500 (5670)			11486 (5210)*	8885 (4030)	24-7 (7486)
9'10" (3.0m)			19886 (9020)*	18166 (8240)	15300 (6940)*	12015 (5450)	13029 (5910)	8686 (3940)	11795 (5350)*	8069 (3660)	25-10 (7868)
4'11" (1.5m)			23435 (10630)*	17218 (7810)	17130 (7770)*	11552 (5240)	12809 (5810)	8488 (3850)	11773 (5340)	7804 (3540)	26-1 (7949)
0			24956 (11320)*	16799 (7620)	17505 (7940)	11266 (5110)	12655 (5740)	8333 (3780)	12125 (5500)	8003 (3630)	25-5 (7741)
-4'11" (-1.5m)	23435 (10630)*	23435 (10630)*	24626 (11170)*	16733 (7590)	17394 (7890)	11177 (5070)			13360 (6060)	8774 (3980)	23-8 (7218)
-9'10" (-3.0m)	31019 (14070)*	31019 (14070)*	22465 (10190)*	16932 (7680)	16513 (7490)*	11332 (5140)			15322 (6950)*	10648 (4830)	20-8 (6300)
-14'9" (-4.5m)	23369 (10600)*	23369 (10600)*	16579 (7520)*	16579 (7520)*					14088 (6390)*	14088 (6390)*	15-7 (4760)

LIFT CAPACITIES – ARM LENGTH: 9'10" (3.0M), MONOBOOM 18'8" (5.7M), TRACKSHOES: 28" (700MM), NO BUCKET. JS220 LC MONO

Reach	9'10" (3m)		14'9" (4.5m)		19'8" (6m)		24'7" (7.5m)		Capacity at Max Reach		ft-in (mm)
											
Load Point Ht.	lb (kg)	lb (kg)	lb (kg)	lb (kg)	lb (kg)	lb (kg)	lb (kg)	lb (kg)	lb (kg)	lb (kg)	
19'8" (6.0m)									8069 (3660)*	8069 (3660)*	24-1 (7332)
14'9" (4.5m)					12192 (5530)*	12192 (5530)*	11530 (5230)*	8929 (4050)	8003 (3630)*	8003 (3630)	26-3 (8011)
9'10" (3.0m)	26125 (11850)*	26125 (11850)*	17946 (8140)*	17946 (8140)*	14154 (6420)*	12081 (5480)	12390 (5620)*	8686 (3940)	8267 (3750)*	7341 (3330)	27-5 (8367)
4'11" (1.5m)			21958 (9960)*	17350 (7870)	16204 (7350)*	11552 (5240)	12787 (5800)	8444 (3830)	8863 (4020)*	7099 (3220)	27-8 (8444)
0	13911 (6310)*	13911 (6310)*	24295 (11020)*	16711 (7580)	17439 (7910)	11177 (5070)	12566 (5700)	8223 (3730)	9921 (4500)*	7231 (3280)	27-1 (8249)
-4'11" (-1.5m)	23104 (10480)*	23104 (10480)*	24736 (11220)*	16513 (7490)	17240 (7820)	11001 (4990)	12478 (5660)	8157 (3700)	11839 (5370)*	7804 (3540)	25-6 (7760)
-9'10" (-3.0m)	33532 (15210)*	32298 (14650)	23435 (10630)*	16601 (7530)	17284 (7840)	11045 (5010)			14110 (6400)	9171 (4160)	22-8 (6916)
-14'9" (-4.5m)	27403 (12430)*	27403 (12430)*	19511 (8850)*	17020 (7720)					15102 (6850)*	12677 (5750)	18-3 (5552)

 Lift capacity front and rear.

 Lift capacity full circle.

Notes:

1. For lifting capacity including bucket, subtract total weight of bucket or bucket and quickhitch from above values.
2. Lifting capacities are based on ISO 10567, that is: 75% of minimum tipping load or 87% of hydraulic lift capacity, whichever is the less. Lifting capacities marked* are based on hydraulic capacity.
3. Lift capacities assume that the machine is on firm, level ground.
4. Lift capacities may be limited by local regulations. Please refer to your dealer.







ONE COMPANY, OVER 300 MACHINES.

HYDRAULIC EXCAVATOR JS220LC

Engine power: 173hp (129kW) Bucket capacity: 14.1 – 42ft³ Operating weight: 48290 – 49582lb

JCB North American – Headquarters

Savannah. 2000 Bamford Blvd., Savannah, Georgia, 31322 Tel: (912) 447-2000

Download the very latest information on this product range at www.jcb.com

JCB inc. All rights reserved. No part of this publication may be reproduced, stored in a retrieval system, or transmitted in any form or by any other means, electronic, mechanical, photocopying or otherwise, without prior permission from JCB inc. All references in this publication to operating weights, sizes, capacities and other performance measurements are provided for guidance only and may vary dependant upon the exact specification of machine. They should not therefore be relied upon in relation to suitability for a particular application. Guidance and advice should always be sought from your JCB Dealer. JCB reserves the right to change specifications without notice. Illustrations and specifications shown may include optional equipment and accessories. The JCB logo is a registered trademark of J C Bamford Excavators Ltd.

Your nearest JCB Dealer

