



TRACKED EXCAVATOR | JZ141 LC/HD

Gross engine power: 74 hp (55 kW) Bucket capacity: 0.46–1.16 yd³ Operating weight: 33,301–39,593 lb



STRENGTH IN DEPTH.

DESIGNED TO WITHSTAND THE RIGOURS OF ANY CONSTRUCTION SITE, THE JCB JZ141 EXCAVATOR IS BUILT FROM THE HIGHEST QUALITY MATERIALS AND COMPONENTS, USING ADVANCED MANUFACTURING TECHNOLOGIES.



1

Boom and dipper.

1 The JCB JZ141 features a reinforced boom and dipper made of high-strength steel, with internal baffle plates for long life durability.

2 Advanced JCB manufacturing and assembly processes produce high precision, premium-quality assembled components.

2



The JCB JZ141 features the industry's best components, including Berco running gear, Kawasaki pumps, Kayaba main control valves and a JCB EcoMAX engine.

The sum of its parts.

3 JCB engines are proven performers, with more than 500,000 engine units built since 2004. The JCB EcoMAX T4F engine in the JZ141 has been tested for more than 110,000 hours in 70 different machines, in the toughest applications and environments in the world.

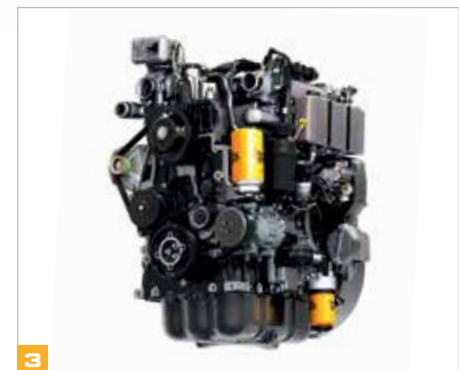

3



Built to last.

- 4 The high-strength undercarriage of a JCB JZ141 uses a fully-welded X-frame construction for long-term durability.
- 5 A closed-box-section revolving frame increases strength, reduces stress and is highly resistant to impact damage.
- 6 The rigid upper frame in the JZ141 provides maximum durability and support. A stiff, durable door design provides added strength.
- 7 The JZ141 has a redesigned dozer blade, with a deeper section, for increased stiffness and durability.

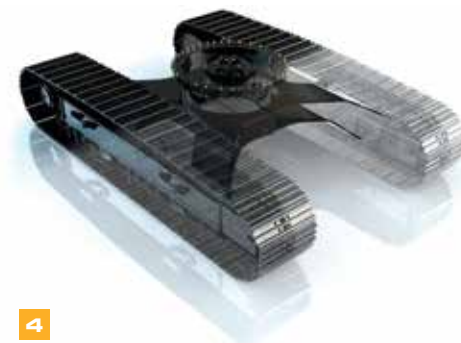

4



5



7



6

PERFORMANCE AND PRODUCTIVITY.

THE JCB JZ141 DELIVERS UNPARALLELED PERFORMANCE AND UNBEATABLE PRODUCTIVITY. THE POWERFUL AND EFFICIENT JCB ECOMAX ENGINE REQUIRES NO DPF OR DEF, AND JCB HYDRAULICS PROVIDE IMPRESSIVE FORCE AND PRECISION CONTROL AT THE DIG END.



Pipework options include hammer, auxiliary, and low-flow. For added versatility, proportional controls are available.

Loads more productive.

1 The JCB quick hitch system is purpose-designed for the JS/JZ range, and makes changing attachments quicker and easier.

2 An optional dozer blade increases versatility for grading.

Optional rubber street pads allow the JZ141 to operate on surfaces such as tarmac and sealed roads, without causing damage.

EcoMAX efficiency.

3 For improved fuel efficiency, the JCB EcoMAX T4F engines produce high torque at just 1500–1600 RPM.

To reduce noise, the speed of the engine-driven cooling fan is optimized via a proportional control system.

Variable power bands allow power and efficiency to be matched to specific tasks.



Always in total control.

4 Simultaneous tracking and excavating is smooth and fast. Proportional controls allow precise command of attachments.

JCB's innovative hydraulic regeneration system recycles oil across the cylinders for faster cycle times and reduced fuel consumption.



With an impressive 20,682 lbf bucket tearout, and a stable work platform for fast cycle times, the JZ141 is extremely productive in all applications.

REDUCED SWING, INCREASED SAFETY.

REDUCED TAIL SWING MAKES THE JZ141 SAFER TO OPERATE AND EASIER TO MANEUVER THAN A CONVENTIONAL TAIL SWING EXCAVATOR.



Safety without compromise.

1 The JZ141 reduced tail swing configuration is preferred for work in urban environments and on confined job sites.

2 The JZ141 is well suited to urban building sites, road works, residential construction, forestry, utilities, railroads and commercial developments.





3

The safe choice.

3 Optional LED lighting improves visibility in low light conditions, boosting both safety and productivity.

4 The JCB JZ141 is fitted with a rear-view camera as standard.

A seat belt warning beacon is available.



4

An optional boxing ring enhances safety when completing daily checks on the upper structure.



COMFORTABLY SUPERIOR.

THE CAB AND CONTROLS CONTRIBUTE TO AN INTUITIVE, COMFORTABLE AND DISTRACTION-FREE WORK ENVIRONMENT, FOR SAFER, MORE PRODUCTIVE OPERATORS.

Total control.

- 1** A 70/30 front windshield provides excellent front visibility and a clear view of the front right track, for safer digging and maneuvering.
- 2** The color, 7-inch, multi-function display is easy to read in all light conditions. The home screen can be customized and operational information is provided in real time.
- 3** JCB's basic tool select system (fitted standard) allows the operator to set the single-direction auxiliary and hammer circuit to match flow requirements. The selected flow is achieved automatically by adjusting the engine revs when the hydraulic service is operated.
- 4** A full-sized cab provides a spacious and comfortable operating environment.



A great place to work.

4 The JZ141 creates a quieter working environment inside and out. Noise levels are reduced to 70 dB (A) inside and 98 dB (A) outside.

JCB cabs use six viscous rubber mounts to minimize noise and vibration.

JCB's climate control option offers a precisely controlled cab temperature with fresh or recirculated air. A positive-pressure environment keeps out dirt and dust.

Demisting/defrosting functions keep the front windshield clear.

5 The cab features a spacious luggage tray behind the operator's seat.

A large floor area with large, high-grip pedals enables easy and precise tracking.

The JCB JZ141 is now available with the Supreme seat, with air suspension, lumbar support and a fully adjustable headrest. The Supreme seat also features ventilation for hot days and a heater for colder conditions.



LESS SERVICING, MORE SERVICE.

THE JCB JZ141 IS EASY TO SERVICE; THE REDESIGNED UPPER STRUCTURE MAKES SCHEDULED MAINTENANCE QUICK AND COST-EFFICIENT.

Access all areas.

1 The JZ141 features large, wide-opening bay doors for unobstructed access. Filters for engine oil, hydraulic oil and fuel are centrally located for fast servicing. The air filter is also conveniently located, and boasts double-element construction for simplified cleaning.

2 The air conditioner condenser unit moves out of the way to provide improved access to the cooling packs.

3 The repositioned valve block is easy to access. All-new hose routing from the valve block provides improved reliability.

	SERVICE INTERVALS
Engine oil and oil filter	Every 500 hours
Hydraulic oil	Every 5000 hours
Hydraulic oil filter	Every 1 000 hours



Saving you time and money.

4 The JCB EcoMAX engine in the JZ141 requires no diesel particulate filter (DPF) or diesel engine fluid (DEF).

On start-up, the in-cab monitor provides system data including engine oil and coolant levels.

An available scavenger filtration system uses suction from the cooling fan to remove heavier particles from the induction system.

The recalibration option allows the JCB EcoMAX engine to run on lower grade fuels, allowing the JZ141 to be resold across territories, for increased residual values.



New and improved.

5 The filter layout on the JCB JZ141 has been improved, and the number of fuel filters has been reduced to two.

Service access is also improved, and the standard-fit fuel shutoff valve allows faster servicing time.

6 The step layout enables safe access to the upper structure.

The main valve block is located under the steps for easy inspection, and the engine can be easily accessed through the counterweight, via a detachable panel.



LIVELINK, WORK SMARTER.

LiveLink tracks the efficiency of your machines to maximize ROI.

- Manage your fleet from anywhere
- Reduce operating costs
- Improve productivity
- Monitor fuel and consumption*
- Receive reports by day / week / month

**For machines with electronic engine management system only*

LiveLink sends service alerts and diagnostic warnings for effective maintenance planning.

- Machine health alerts
- Machine service alerts
- Accurate hours recorded
- Detailed machine history



LiveLink reports the exact location, movement and activity of your machine for improved security.

- Pinpoint machine location
- 24/7 update on your phone/tablet
- Real-time curfew alerts
- Real-time geofence alerts
- Back-up battery
- Tow-away alert



Enhanced Dealer Support

JCB LiveLink

Machine Servicing Agreement



Superior Build Quality

Note: Please consult your local dealer for LiveLink availability.

VALUE ADDED.

WHATEVER YOU NEED AND WHEREVER YOU ARE, THE DEPENDABLE JCB DEALER NETWORK IS HERE TO MAKE SURE YOUR MACHINERY PERFORMS TO ITS FULL POTENTIAL.



1 JCB Technical Support Service provides instant access to factory expertise, day or night. JCB's Finance and Insurance teams are always on hand to provide fast, flexible, competitive quotes.

2 The global network of JCB Parts Centers is a model of efficiency. With 16 regional bases, we can deliver around 95 percent of all parts anywhere in the world within 24 hours. Our genuine JCB parts are designed to work in perfect harmony with your machine for optimum performance and productivity.



3 JCB Yellow Shield offers comprehensive extended warranties and service agreements, as well as service-only or repair and maintenance contracts. JCB maintenance teams offer competitive labor rates and no obligation quotes.



JCB LiveLink and JCB Yellow Shield may not be available in your region, so please check with your local dealer.

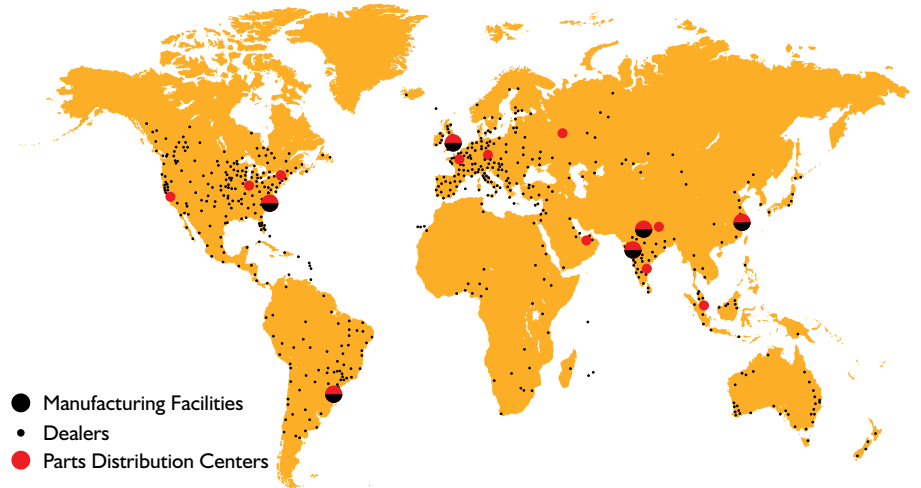

STATIC DIMENSIONS

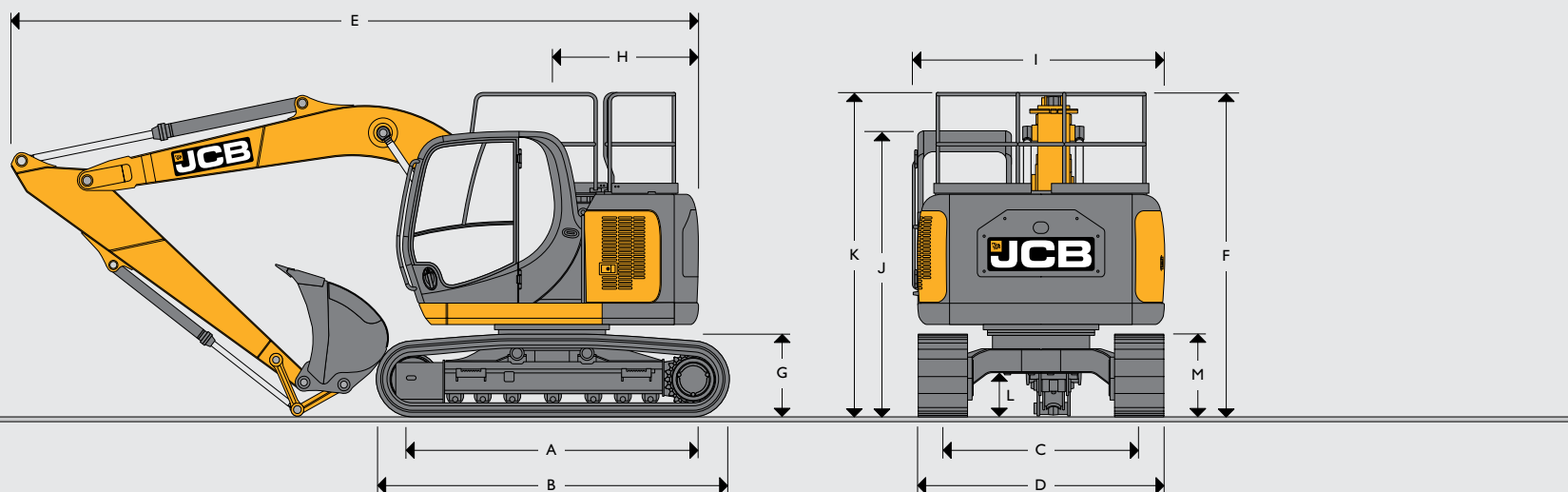

STATIC DIMENSIONS

Dimensions		Monoboom								
		LC				HD				
A	Track length on ground	ft-in (mm)	9- 5 (2,865)				10- 1 (3,075)			
B	Undercarriage overall length	ft-in (mm)	11- 9 (3,590)				12- 6 (3,812)			
C	Track gauge	ft-in (mm)	6- 6 (1,990)				7- 3 (2,200)			
D	Width over tracks (500 mm trackshoes)	ft-in (mm)	8- 2 (2,490)				-			
D	Width over tracks (600 mm trackshoes)	ft-in (mm)	8- 6 (2,590)				9- 2 (2,800)			
D	Width over tracks (700 mm trackshoes)	ft-in (mm)	8- 10 (2,690)				9- 6 (2,900)			
D	Width over tracks (800 mm trackshoes)	ft-in (mm)	-				9- 10 (3,000)			
D	Width over tracks (850 mm trackshoes)	ft-in (mm)	9- 4 (2,840)				-			
D	Width over tracks (900 mm trackshoes)	ft-in (mm)	-				10- 2 (3,100)			
Boom options		ft-in (mm)	Monoboom 15-5 (4,700)							
Dipper lengths			6- 11 (2,100)	8- 2 (2,500)	8- 10 (2,700)	9- 10 (3,000)	6- 11 (2,100)	8- 2 (2,500)	8- 10 (2,700)	9- 10 (3,000)
E	Transport length	ft-in (mm)	24- 0 (7,306)	24- 1 (7,331)	23- 10 (7,275)	23- 11 (7,284)	24- 0 (7,306)	24- 1 (7,331)	23- 10 (7,275)	23- 11 (7,284)
F	Transport height	ft-in (mm)	10- 7 (3,227)	10- 7 (3,227)	10- 10 (3,300)	10- 11 (3,318)	10- 11 (3,337)	10- 11 (3,337)	11- 2 (3,410)	11- 3 (3,428)
F	Transport height with handrail folded (optional)	ft-in (mm)	9- 6 (2,887)	9- 7 (2,917)	10- 10 (3,300)	10- 11 (3,318)	9- 10 (2,988)	9- 11 (3,028)	11- 2 (3,410)	11- 3 (3,428)
G	Counterweight clearance	ft-in (mm)	3- 0 (916)				3- 4 (1,026)			
H	Tailswing radius	ft-in (mm)	4- 10 (1,485)				4- 10 (1,485)			
I	Width of superstructure	ft-in (mm)	8- 2 (2,500)				8- 2 (2,500)			
J	Height over cab	ft-in (mm)	9- 4 (2,842)				9- 8 (2,952)			
K	Height over grab rail	ft-in (mm)	10- 7 (3,227)				10- 11 (3,337)			
L	Ground clearance	ft-in (mm)	1- 5 (434)				1- 5 (440)			
M	Track height	ft-in (mm)	2- 8 (820)				2- 9 (832)			

ENGINE	
Model	JCB EcoMAX 444 TCA 55 EU Stage IIIB, EPA Tier 4 Final compliant.
Type	Water cooled, 4-stroke, 4-cylinder in-line, common rail direct injection, turbocharged variable geometry intercooled diesel.
Rated power (ISO 14396)	74 hp (55 kW) @ 2200 RPM
Piston displacement	4.4 litres.
Air filtration	Dry element with secondary safety element and in-cab warning indicator.
Starting system	24 V
Batteries	2 x 12 V
Alternator	24 V, 55 amp

SLEW SYSTEM	
Slew motor	Axial piston type.
Slew brake	Hydraulic braking plus automatic spring applied disc type parking brake.
Slew torque	ft lb (kNm) 8,116 (36.1)
Slew speed	13.1 RPM
Slew gear	Large diameter, internally toothed fully sealed grease bath lubricated.

TRACK DRIVE			
Type	Fully hydrostatic, two speed with autoshift.		
Travel motors	Variable swash axial piston type, fully guarded within undercarriage frame.		
Final drive	Planetary reduction, bolt-on sprockets.		
Service brake	Hydraulic counter balance valve.		
Park brake	Disc type, spring applied, automatic hydraulic release.		
Gradability	70% (35 deg) continuous.		
Travel speed	LC	HD	
	mph (kph)	High - 3.18 (5.12)	High - 2.66 (4.28)
Tractive effort	LC	HD	
	mph (kph)	Low - 1.86 (3)	Low - 1.53 (2.47)
Tractive effort	ft lb (kNm)	27,089 (120.5)	32,800 (145.9)

SERVICE CAPACITIES	
	Gallons (Liters)
Fuel tank	53.63 (203)
Engine coolant	6.23 (23.6)
Engine oil	3.7 (14)
Swing reduction gear	.58 (2.2)
Track reduction gear (each side)	.92 (3.5)
Hydraulic system	42.27 (160)
Hydraulic tank	17.7 (67)

UNDERCARRIAGE							
Carriage options	LC - Long Carriage, HD - Heavy Duty Carriage.						
Construction	Fully welded 'X-Frame type and sloping sidemembers with dirt relief holes under top rollers.						
Recovery point	Front and rear.						
Track shoes	in (mm)	20 (500)	24 (600)	28 (700)	32 (800)	33 (850)	35 (900)
LC		● X	●	●		●	
HD			●	●	●		●
Upper & lower rollers	Heat treated, sealed and lubricated.						
Track adjustment	Grease cylinder type.						
Track idler	Sealed and lubricated, with spring cushioned recoil.						
Track type	Sealed and lubricated.						
Rollers and shoes (each side)		LC			HD		
No. of track guides (optional)		2			2		
No. of lower rollers		7			7		
No. of upper rollers		2			2		
No. of track shoes		44			43		

● = Triple grouser, X = Geogrip.

HYDRAULIC SYSTEM		
Open centred, negative control hydraulic system with twin variable flow piston pumps providing flow-on-demand.		
Pumps		
Main pumps	2 variable displacement axial piston type.	
Maximum flow	gpm (lpm)	2 x 34.34 (2 x 130)
Servo pump	Gear type.	
Maximum flow	gpm (lpm)	2 x 5.42 (2 x 20.5)
Control valve		
A combined four and five spool control valve with auxiliary service spool as standard.		
Relief valve settings		
Boom/Arm/Bucket	psi (bar)	4,554 (314)
With power boost	psi (bar)	4,975 (343)
Slew circuit	psi (bar)	4,047 (279)
Travel circuit	psi (bar)	4,975 (343)
Pilot control	psi (bar)	580 (40)
Filtration		
In tank	150 micron, suction strainer.	
Main return line	10 micron, glass fibre element.	
Pilot line	10 micron, paper element.	
Hydraulic hammer return	10 micron, reinforced microform element.	

BUCKET AND ARM COMBINATION - MONOBOOM

Bucket options		GP Bucket						HD Bucket						Grade Bucket		
Bucket width	in (mm)	24 (600)	28 (700)	31 (800)	39 (1,000)	47 (1,200)	51 (1,300)	24 (600)	28 (700)	31 (800)	39 (1,000)	47 (1,200)	51 (1,300)	60 (1,524)	72 (1,836)	72 (1,836)
Bucket capacity	yd ³ (m ³)	.46 (0.35)	.55 (0.42)	.65 (0.50)	.86 (0.66)	1.06 (0.81)	1.16 (0.89)	.46 (0.35)	.55 (0.42)	.65 (0.50)	.86 (0.66)	1.06 (0.81)	1.16 (0.89)	.85 (0.65)	1.03 (0.79)	1.03 (0.79)
Bucket weight	lbs (kg)	705 (320)	758 (344)	836 (379)	966 (438)	1,067 (484)	1,146 (520)	741 (336)	802 (364)	886 (402)	1,003 (455)	1,146 (520)	1,204 (546)	999 (453)	1,153 (523)	1,283 (582)
LC ft-in(m)																
6-11 (2.1) Quickhitch (No Quickhitch)		☐ (☐)	☐ (☐)	☐ (☐)	☐ (☐)	☐ (☐)	■ (☐)	☐ (☐)	☐ (☐)	☐ (☐)	☐ (☐)	☐ (☐)	■ (☐)	☐ (☐)	☐ (☐)	☐ (☐)
8-2 (2.5) Quickhitch (No Quickhitch)		☐ (☐)	☐ (☐)	☐ (☐)	☐ (☐)	■ (☐)	■ (■)	☐ (☐)	☐ (☐)	☐ (☐)	☐ (☐)	■ (☐)	■ (■)	☐ (☐)	■ (☐)	■ (☐)
8-10 (2.7) Quickhitch (No Quickhitch)		☐ (☐)	☐ (☐)	☐ (☐)	☐ (☐)	■ (☐)	● (■)	☐ (☐)	☐ (☐)	☐ (☐)	☐ (☐)	■ (■)	● (■)	☐ (☐)	■ (☐)	■ (■)
9-10 (3) Quickhitch (No Quickhitch)		☐ (☐)	☐ (☐)	☐ (☐)	☐ (☐)	● (■)	● (■)	☐ (☐)	☐ (☐)	☐ (☐)	■ (☐)	● (■)	● (●)	☐ (☐)	● (■)	● (■)
LC + Dozer ft-in(m)																
6-11 (2.1) Quickhitch (No Quickhitch)		☐ (☐)	☐ (☐)	☐ (☐)	☐ (☐)	☐ (☐)	☐ (☐)	☐ (☐)	☐ (☐)	☐ (☐)	☐ (☐)	☐ (☐)	☐ (☐)	☐ (☐)	☐ (☐)	☐ (☐)
8-2 (2.5) Quickhitch (No Quickhitch)		☐ (☐)	☐ (☐)	☐ (☐)	☐ (☐)	☐ (☐)	■ (☐)	☐ (☐)	☐ (☐)	☐ (☐)	☐ (☐)	■ (☐)	■ (☐)	☐ (☐)	☐ (☐)	■ (☐)
8-10 (2.7) Quickhitch (No Quickhitch)		☐ (☐)	☐ (☐)	☐ (☐)	☐ (☐)	■ (☐)	■ (■)	☐ (☐)	☐ (☐)	☐ (☐)	☐ (☐)	■ (☐)	■ (■)	☐ (☐)	■ (☐)	■ (☐)
9-10 (3) (No Quickhitch)		☐ (☐)	☐ (☐)	☐ (☐)	☐ (☐)	■ (■)	● (■)	☐ (☐)	☐ (☐)	☐ (☐)	☐ (☐)	■ (■)	● (■)	☐ (☐)	■ (■)	■ (■)
HD ft-in(m)																
6-11 (2.1) Quickhitch (No Quickhitch)		☐ (☐)	☐ (☐)	☐ (☐)	☐ (☐)	☐ (☐)	☐ (☐)	☐ (☐)	☐ (☐)	☐ (☐)	☐ (☐)	☐ (☐)	☐ (☐)	☐ (☐)	☐ (☐)	☐ (☐)
8-2 (2.5) Quickhitch (No Quickhitch)		☐ (☐)	☐ (☐)	☐ (☐)	☐ (☐)	☐ (☐)	■ (☐)	☐ (☐)	☐ (☐)	☐ (☐)	☐ (☐)	☐ (☐)	■ (☐)	☐ (☐)	☐ (☐)	☐ (☐)
8-10 (2.7) Quickhitch (No Quickhitch)		☐ (☐)	☐ (☐)	☐ (☐)	☐ (☐)	☐ (☐)	☐ (☐)	☐ (☐)	☐ (☐)	☐ (☐)	☐ (☐)	☐ (☐)	☐ (☐)	☐ (☐)	☐ (☐)	☐ (☐)
9-10 (3) (No Quickhitch)		☐ (☐)	☐ (☐)	☐ (☐)	☐ (☐)	■ (☐)	■ (☐)	☐ (☐)	☐ (☐)	☐ (☐)	☐ (☐)	■ (☐)	■ (■)	☐ (☐)	■ (☐)	■ (☐)

- = Material weight up to 2,023 lb/yd³ (1,200 kg/m³)
- = Material weight up to 2,697 lb/yd³ (1,600 kg/m³)
- ☐ = Material weight up to 3,371 lb/yd³ (2,000 kg/m³)

These recommendations are given as a guide based on typical operating conditions. Please contact your distributor for the correct selection of buckets and attachments to suit the application.

WEIGHTS AND GROUND BEARING PRESSURES

Figures include 966 lb (438 kg) bucket, operator, full fuel tank and 8'2" (2.5 m) dipper.

Shoes	in (mm)	20 (500)	24 (600)	28 (700)	32 (800)	33 (850)	35 (900)
LC Monoboomb							
Machine weight	lb (kg)	33,389 (15,145)	33,863 (15,360)	34,339 (15,576)	-	35,051 (15,899)	-
Ground bearing pressure	psi (kg/cm ²)	6.83 (0.48)	5.83 (0.41)	5.12 (0.36)	-	4.27 (0.30)	-
HD Monoboomb							
Machine weight	lb (kg)	-	36,835 (16,708)	37,355 (16,944)	37,880 (17,182)	-	38,400 (17,418)
Ground bearing pressure	psi (kg/cm ²)	-	5.97 (0.42)	5.12 (0.36)	4.55 (0.32)	-	4.12 (0.29)
LC Mono Dozer							
Machine weight	lb (kg)	35,089 (15,916)	35,580 (16,139)	36,076 (16,139)	-	-	-
Ground bearing pressure	psi (kg/cm ²)	7.25 (0.51)	6.12 (0.43)	5.26 (0.37)	-	-	-

OPTIONAL BLADE

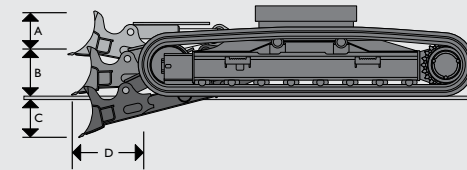

A	Blade height	ft-in (mm)	1-6 (447)
B	Blade lift above ground	ft-in (mm)	1-7 (494)
C	Blade cut below ground	ft-in (mm)	1-8 (508)
D	Blade forward of track	ft-in (mm)	1-4 (412)
	Dozer width – 20" (500 mm) tracks	ft-in (mm)	8-3 (2,510)
	Dozer width – 24" (600 mm) tracks	ft-in (mm)	8-7 (2,610)
	Dozer width – 28" (700 mm) tracks	ft-in (mm)	8-11 (2,710)

Additional machine weight with blade

20" (500 mm) tracks	lb (kg)	1,402 (636)
24" (600 mm) tracks	lb (kg)	1,420 (644)
28" (700 mm) tracks	lb (kg)	1,440 (653)

Dozer not available with 32", 33", 35" (800, 850 and 900 mm) track plates.

WORKING RANGE - LC MONOBOOM 15'5" (4.7 m)

Dipper length:		6-11 (2.1)	8-2 (2.5)	8-10 (2.7)	9-10 (3)	
A	Maximum digging reach	ft-in (mm)	26-1 (7,961)	27-4 (8,331)	27-9 (8,465)	28-10 (8,787)
B	Maximum digging reach (on ground)	ft-in (mm)	25-7 (7,810)	26-10 (8,187)	27-4 (8,324)	28-5 (8,651)
C	Maximum digging depth	ft-in (mm)	16-11 (5,154)	18-3 (5,557)	18-11 (5,762)	19-10 (6,055)
D	Maximum digging height	ft-in (mm)	29-2 (8,886)	30-1 (9,160)	30-5 (9,275)	31-1 (9,469)
E	Maximum dumping height	ft-in (mm)	21-1 (6,418)	21-11 (6,692)	22-4 (6,807)	23-0 (7,015)
F	Maximum vertical wall cut depth	ft-in (mm)	15-1 (4,590)	16-4 (4,986)	16-8 (5,073)	18-0 (5,488)
G	Minimum swing radius	ft-in (mm)	6-11 (2,117)	7-2 (2,175)	8-1 (2,468)	8-4 (2,535)
	Bucket rotation	deg	182	182	(182)	(182)
	Maximum dipper tearout	ft lb (kNm)	16,793 (74.7)	14,905 (66.3)	14,568 (64.8)	13,511 (60.1)
	Maximum bucket tearout	ft lb (kNm)	20,682 (92)	20,682 (92)	20,682 (92)	20,682 (92)

WORKING RANGE - HD MONOBOOM 15'5" (4.7 m)



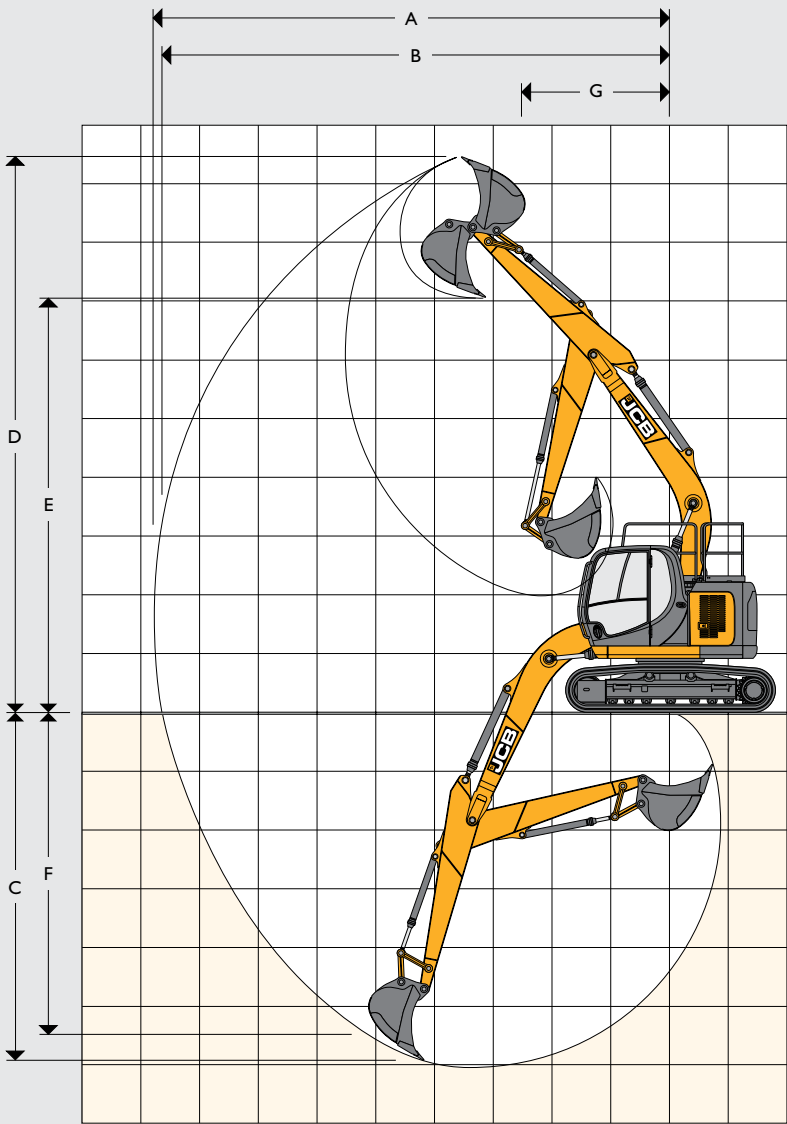











Dipper length:		6-11 (2.1)	8-2 (2.5)	8-10 (2.7)	9-10 (3)	
A	Maximum digging reach	ft-in (mm)	26-1 (7,961)	27-4 (8,331)	27-9 (8,465)	28-10 (8,787)
B	Maximum digging reach (on ground)	ft-in (mm)	25-7 (7,810)	26-10 (8,187)	27-4 (8,324)	28-5 (8,651)
C	Maximum digging depth	ft-in (mm)	16-7 (5,044)	17-10 (5,447)	18-7 (5,652)	19-6 (5,945)
D	Maximum digging height	ft-in (mm)	29-6 (8,996)	30-5 (9,270)	30-9 (9,385)	31-5 (9,579)
E	Maximum dumping height	ft-in (mm)	21-5 (6,528)	22-4 (6,802)	22-8 (6,917)	23-5 (7,125)
F	Maximum vertical wall cut depth	ft-in (mm)	14-8 (4,480)	16-0 (4,876)	16-3 (4,963)	17-8 (5,378)
G	Minimum swing radius	ft-in (mm)	6-11 (2,117)	7-2 (2,175)	8-1 (2,468)	8-4 (2,535)
	Bucket rotation	deg	(182)	(182)	(182)	(182)
	Maximum dipper tearout	ft lb (kNm)	16,793 (74.7)	14,905 (66.3)	14,568 (64.8)	13,511 (60.1)
	Maximum bucket tearout	ft lb (kNm)	20,682 (92)	20,682 (92)	20,682 (92)	20,682 (92)

















STANDARD/OPTIONAL EQUIPMENT

	JZ141	JZ141 HD		JZ141	JZ141 HD		JZ141	JZ141 HD
ENGINE			CAB & INTERIOR			SAFETY		
JCB EcoMAX 74 hp EGR, water-cooled diesel engine with Fixed Turbo Charger and air-to-air intercooler	•	•	Sound-insulated and 6 shock-mounted cab	•	•	Side guard rails on upper structure and steps	•	•
Start pre-heat	•	•	Mechanical suspension seat	•	•	Rear-view camera	•	•
One touch idle	•	•	Opening front window and removable lower front window	•	•	Battery isolator	•	•
Auto-idle function	•	•	Sliding left window	•	•	Key	•	•
Fan guard	•	•	Upper windscreen wiper	•	•	2 GO	•	•
Heavy duty batteries	•	•	3-button joysticks	•	•	Lockable fuel cap	•	•
Fuel filter with water separator	•	•	Travel pedals and T-hand levers	•	•	Work lights (1 main frame, 2 boom mounted, 1 counterweight)	•	•
Fuel shutoff tap	•	•	Immobilizer	•	•	Additional work lights (2 cab mounted)	+	+
Electronic engine control	•	•	Loudspeakers and connections for radio	•	•	LED work light upgrade	+	+
Fuel Cooler	•	•	Standard cab filtration	•	•	Folding side guard rails on upper structure	+	+
Refuelling pump	+	+	Electric horn	•	•	FOPS II guards - top and front	+	+
Scavenge air filter	+	+	Interior cab light	•	•	Mesh screen guards	+	+
HYDRAULIC SYSTEM			12V power socket	•	•	Travel alarm	+	+
Boom and arm flow regeneration	•	•	7-color monitor	•	•	White noise travel alarm	+	+
One-touch power boost function	•	•	Roof blind	•	•	Green beacon linked seat belt	+	+
Cushion control	•	•	Retractable 2 seat belt	•	•	Fire extinguisher	+	+
Cylinder cushioning & contamination seals	•	•	Air conditioning with climate control	+	+	Vandal guards	+	+
Oil cooler	•	•	3-point seat belt	+	+	Chevron counterweight	+	+
Control of auxiliary hydraulic flow and pressure from display panel with 10 tool setting storage	+	+	Full-length front blind	+	+	Roll Over Protective Structure (ROPS)	+	+
High and low flow aux options	+	+	Half-length front blind	+	+	Boom and arm cylinder safety valves & overload warning	+	+
Proportional auxiliary controls	+	+	Heated, adjustable air suspension seat with adjustable headrest and armrest	+	+	Rear counterweight safety handrails	+	+
Breaker piping	+	+	Lower windshield wiper	+	+	Rotating beacon	+	+
Bio oil	+	+	Radio	+	+	2 x counterweight beacons	+	+
Panolin oil	+	+	Carbon air filter	+	+	OTHER		
Quick hitch pipework	+	+	Deluxe seat	+	+	LiveLink telematics	•	•
Hydraulic hitch	+	+	Rain visor	+	+	Tracked tool kit	+	+
ISO/SAE changeover	+	+	HYDRAULIC SYSTEM			Guards for work lights	+	+
Quick release couplings	+	+	Greased and sealed track links	•	•	• STANDARD		
Hose burst check valves	+	+	20", 24", 28", 33" triple grouser shoe	+	N/A	+ OPTIONAL		
Shut off taps	+	+	24", 28" heavy duty triple grouser shoe	+	N/A	N/A NOT AVAILABLE		
Dipper limiter	+	+	20" pre-drilled track plates	+	N/A			
DIG END			20" Geogrip rubber pads	+	N/A			
No lift tipping link	•	•	Dozer blade	+	N/A			
Dippers: 6'11", 8'2", 9'10"	+	+	24", 28", 32", 35" triple grouser shoe	N/A	+			
Lifting hook tipping link	+	+	24", 28", 32", 35" heavy duty triple grouser shoe		+			
Lifting shackle tipping link	+	+	Twin track guards	+	+			
Bucket ram guards	+	+						
Triple Articulating Boom (TAB)	+	+						
Bucket/grab changeover	+	+						















LIFT CAPACITIES – DIPPER LENGTH: 6'11" (2.1 m), 15'5" (4.7 m) MONOBOOM, TRACKSHOES: 20" (500 mm), NO BUCKET **JZ141 LC MONO**

Reach ft-in(m)	6-7 (2)		9-10 (3)		13-1 (4)		16-5 (5)		19-8 (6)		23-0 (7)		Capacity at Max Reach		ft-in (mm)
															
Load Point Ht.	lb (kg)	lb (kg)	lb (kg)	lb (kg)	lb (kg)	lb (kg)	lb (kg)	lb (kg)	lb (kg)	lb (kg)	lb (kg)	lb (kg)	lb (kg)	lb (kg)	lb (kg)
19-8 (6)					8,774 (3,980*)	8,774 (3,980*)	6,504 (2,950*)	6,504 (2,950*)					6,482 (2,940*)	6,482 (2,940*)	16-5 (5,001)
16-5 (5)					9,149 (4,150*)	9,149 (4,150*)	9,061 (4,110*)	6,856 (3,110)					6,041 (2,740*)	5,401 (2,450)	18-10 (5,750)
13-1 (4)	15,873 (7,200*)	15,873 (7,200*)	12,147 (5,510*)	12,147 (5,510*)	10,494 (4,760*)	9,546 (4,330)	9,634 (4,370*)	6,724 (3,050)	7,606 (3,450)	5,004 (2,270)			5,864 (2,660*)	4,652 (2,110)	20-6 (6,251)
9-10 (3)			16,424 (7,450*)	14,132 (6,410)	12,478 (5,660*)	9,083 (4,120)	9,987 (4,530)	6,482 (2,940)	7,496 (3,400)	4,894 (2,220)			5,864 (2,660*)	4,233 (1,920)	21-6 (6,562)
6-7 (2)					13,757 (6,240)	8,598 (3,900)	9,700 (4,400)	6,239 (2,830)	7,363 (3,340)	4,762 (2,160)			6,019 (2,730*)	4,012 (1,820)	22-0 (6,709)
3-3 (1)					13,316 (6,040)	8,201 (3,720)	9,458 (4,290)	5,997 (2,720)	7,231 (3,280)	4,630 (2,100)			6,129 (2,780)	3,946 (1,800)	22-0 (6,704)
0-0 (0)			14,065 (6,380*)	12,258 (5,560)	13,051 (5,920)	7,981 (3,620)	9,281 (4,210)	5,842 (2,650)	7,121 (3,230)	4,542 (2,060)			6,283 (2,850)	4,034 (1,830)	21-6 (6,546)
-3-3 (-1)	10,626 (4,820*)	10,626 (4,820*)	20,790 (9,430*)	12,236 (5,550)	12,963 (5,880)	7,893 (3,580)	9,193 (4,170)	5,776 (2,620)	7,077 (3,210)	4,519 (2,050)			6,746 (3,060)	4,079 (1,950)	20-5 (6,224)
-6-7 (-2)	18,475 (8,380*)	18,475 (8,380*)	21,297 (9,660*)	12,346 (5,600)	12,985 (5,890)	7,915 (3,590)	9,215 (4,180)	5,776 (2,620)					7,650 (3,470)	4,872 (2,210)	18-9 (5,709)
-9-10 (-3)	24,846 (11,270*)	24,846 (11,270*)	18,739 (8,500*)	12,566 (5,700)	13,162 (5,970)	8,047 (3,650)							9,568 (4,340)	6,041 (2,740)	16-2 (4,940)

LIFT CAPACITIES – DIPPER LENGTH: 6'11" (2.1 m), 15'5" (4.7 m) MONOBOOM, TRACKSHOES: 20" (500 mm), NO BUCKET, DOZER **JZ141 LC MONO**

Reach ft-in(m)	6-7 (2)		9-10 (3)		13-1 (4)		16-5 (5)		19-8 (6)		23-0 (7)		Capacity at Max Reach		ft-in (mm)
															
Load Point Ht.	lb (kg)	lb (kg)	lb (kg)	lb (kg)	lb (kg)	lb (kg)	lb (kg)	lb (kg)	lb (kg)	lb (kg)	lb (kg)	lb (kg)	lb (kg)	lb (kg)	lb (kg)
19-8 (6)					8,774 (3,980*)	8,774 (3,980*)	6,504 (2,950*)	6,504 (2,950*)					6,482 (2,940*)	6,482 (2,940*)	16-5 (5,001)
16-5 (5)					9,149 (4,150*)	9,149 (4,150*)	9,061 (4,110*)	7,209 (3,270)					6,041 (2,740*)	5,688 (2,580)	18-10 (5,750)
13-1 (4)	15,873 (7,200*)	15,873 (7,200*)	12,147 (5,510*)	12,147 (5,510*)	10,494 (4,760*)	10,009 (4,540)	9,634 (4,370*)	7,077 (3,210)	8,047 (3,650)	5,269 (2,390)			5,864 (2,660*)	4,916 (2,230)	20-6 (6,251)
9-10 (3)			16,424 (7,450*)	14,837 (6,730)	12,478 (5,660*)	9,546 (4,330)	10,560 (4,790)	6,834 (3,100)	7,959 (3,610)	5,181 (2,350)			5,864 (2,660*)	4,475 (2,030)	21-6 (6,562)
6-7 (2)					14,551 (6,600)	9,061 (4,110)	10,274 (4,660)	6,570 (2,980)	7,804 (3,540)	5,049 (2,290)			6,019 (2,730*)	4,255 (1,930)	22-0 (6,709)
3-3 (1)					14,110 (6,400)	8,664 (3,930)	10,031 (4,550)	6,349 (2,880)	7,672 (3,480)	4,916 (2,230)			6,349 (2,880*)	4,189 (1,900)	22-0 (6,704)
0-0 (0)			14,065 (6,380*)	12,963 (5,880)	13,845 (6,280)	8,444 (3,830)	9,855 (4,470)	6,195 (2,810)	7,562 (3,430)	4,828 (2,190)			6,680 (3,030)	4,277 (1,940)	21-6 (6,546)
-3-3 (-1)	10,626 (4,820*)	10,626 (4,820*)	20,790 (9,430*)	12,941 (5,870)	13,757 (6,240)	8,356 (3,790)	9,766 (4,430)	5,004 (2,770)	7,518 (3,410)	4,784 (2,170)			7,165 (3,250)	4,564 (2,070)	20-5 (6,224)
-6-7 (-2)	18,475 (8,380*)	18,475 (8,380*)	21,297 (9,660*)	13,029 (5,910)	13,779 (6,250)	8,378 (3,800)	9,766 (4,430)	6,129 (2,780)					8,113 (3,680)	5,159 (2,340)	18-9 (5,709)
-9-10 (-3)	24,846 (11,270*)	24,846 (11,270*)	18,739 (8,500*)	13,272 (6,020)	13,933 (6,320)	8,510 (3,860)							10,141 (4,600)	6,393 (2,900)	16-2 (4,940)

LIFT CAPACITIES – DIPPER LENGTH: 6'11" (2.1 m), 15'5" (4.7 m) MONOBOOM, TRACKSHOES: 24" (500 mm), NO BUCKET **JZ141 LC MONO**



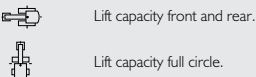











Reach ft-in(m)	6-7 (2)		9-10 (3)		13-1 (4)		16-5 (5)		19-8 (6)		23-0 (7)		Capacity at Max Reach		ft-in (mm)
															
Load Point Ht.	lb (kg)	lb (kg)	lb (kg)	lb (kg)	lb (kg)	lb (kg)	lb (kg)	lb (kg)	lb (kg)	lb (kg)	lb (kg)	lb (kg)	lb (kg)	lb (kg)	lb (kg)
19-8 (6)					8,774 (3,980*)	8,774 (3,980*)	6,504 (2,950*)	6,504 (2,950*)					6,482 (2,940*)	6,482 (2,940*)	16-5 (5,001)
16-5 (5)					9,149 (4,150*)	9,149 (4,150*)	9,061 (4,110*)	8,620 (3,910)					6,041 (2,740*)	6,041 (2,740*)	18-10 (5,750)
13-1 (4)	15,873 (7,200*)	15,873 (7,200*)	12,147 (5,510*)	12,147 (5,510*)	10,494 (4,760*)	10,494 (4,760*)	9,634 (4,370*)	8,466 (3,840)	8,973 (4,070*)	6,349 (2,880)			5,864 (2,660*)	5,864 (2,660*)	20-6 (6,251)
9-10 (3)			16,424 (7,450*)	16,424 (7,450*)	12,478 (5,660*)	11,552 (5,240)	10,648 (4,830*)	8,245 (3,740)	8,907 (4,040)	6,239 (2,830)			5,864 (2,660*)	5,423 (2,460)	21-6 (6,562)
6-7 (2)					14,617 (6,630*)	11,045 (5,010)	11,574 (5,250)	7,959 (3,610)	8,752 (3,970)	6,107 (2,770)			6,019 (2,730*)	5,159 (2,340)	22-0 (6,709)
3-3 (1)					16,116 (7,310)	10,626 (4,820)	11,332 (5,140)	7,738 (3,510)	8,620 (3,910)	5,975 (2,710)			6,349 (2,880*)	5,093 (2,310)	22-0 (6,704)
0-0 (0)			14,065 (6,380*)	14,065 (6,380*)	15,851 (7,190)	10,406 (4,720)	11,133 (5,050)	7,562 (3,430)	8,510 (3,860)	5,886 (2,670)			6,900 (3,130*)	5,225 (2,370)	21-6 (6,546)
-3-3 (-1)	10,626 (4,820*)	10,626 (4,820*)	20,730 (9,430*)	16,270 (7,380)	15,741 (7,140)	10,318 (4,680)	11,045 (5,010)	7,496 (3,400)	8,488 (3,850)	5,842 (2,650)			7,782 (3,530*)	5,578 (2,530)	20-5 (6,224)
-6-7 (-2)	18,475 (8,380*)	18,475 (8,380*)	21,297 (9,660*)	16,380 (7,430)	15,763 (7,150)	10,340 (4,690)	11,067 (5,020)	7,496 (3,400)					9,149 (4,150)	6,305 (2,860)	18-9 (5,709)
-9-10 (-3)	24,846 (11,270*)	24,846 (11,270*)	18,739 (8,500*)	16,623 (7,540)	14,528 (6,590*)	10,494 (4,760)							10,979 (4,980*)	7,804 (3,540)	16-2 (4,940)

















Notes:

1. For lifting capacity including bucket, subtract total weight of bucket or bucket and quickhitch from above values.
2. Lifting capacities are based on ISO 10567, that is: 75% of minimum tipping load or 87% of hydraulic lift capacity, whichever is the less. Lifting capacities marked* are based on hydraulic capacity.
3. Lift capacities assume that the machine is on firm, level ground.
4. Lift capacities may be limited by local regulations. Please refer to your dealer.















LIFT CAPACITIES – DIPPER LENGTH: 8'2" (2.5 m), 15'5" (4.7 m) MONOBOOM, TRACKSHOES: 20" (500 mm), NO BUCKET **JZ141 LC MONO**

Reach ft-in (m)	6-7 (2)		9-10 (3)		13-1 (4)		16-5 (5)		19-8 (6)		23-0 (7)		Capacity at Max Reach			
																ft-in (mm)
Load Point Ht.	lb (kg)	lb (kg)	lb (kg)	lb (kg)	lb (kg)	lb (kg)	lb (kg)	lb (kg)	lb (kg)	lb (kg)	lb (kg)	lb (kg)	lb (kg)	lb (kg)	lb (kg)	ft-in (mm)
19-8 (6)					7,606 (3,450)*	7,606 (3,450)*	8,069 (3,660)*	7,011 (3,180)						5,203 (2,360)*	5,203 (2,360)*	18-0 (5,490)
16-5 (5)					8,091 (3,670)*	8,091 (3,670)*	8,201 (3,720)*	6,967 (3,160)	6,548 (2,970)*	5,115 (2,320)				4,894 (2,220)*	4,828 (2,190)	20-3 (6,179)
13-1 (4)			10,406 (4,720)*	10,406 (4,720)*	9,436 (4,280)*	9,436 (4,280)*	8,885 (4,030)*	6,812 (3,090)	7,694 (3,490)	5,071 (2,300)				4,762 (2,160)*	4,233 (1,920)	21-10 (6,648)
9-10 (3)			14,462 (6,560)*	14,462 (6,560)*	11,442 (5,190)*	9,237 (4,190)	9,965 (4,520)*	6,570 (2,980)	7,562 (3,430)	4,938 (2,240)				4,762 (2,160)*	3,880 (1,760)	22-9 (6,941)
6-7 (2)			18,982 (8,610)*	13,382 (6,070)	13,691 (6,210)*	8,708 (3,950)	9,766 (4,430)	6,283 (2,850)	7,385 (3,350)	4,784 (2,170)	7,628 (3,640)	3,748 (1,700)		4,894 (2,220)*	3,682 (1,670)	23-3 (7,080)
3-3 (1)			14,881 (6,750)*	12,588 (5,710)	13,404 (6,080)	8,267 (3,750)	9,480 (4,300)	6,019 (2,730)	7,231 (3,280)	4,630 (2,100)	5,732 (2,600)	3,682 (1,670)		5,137 (2,330)*	3,616 (1,640)	23-3 (7,076)
0-0 (0)			15,631 (7,090)*	12,236 (5,550)	13,073 (5,930)	7,981 (3,620)	9,281 (4,210)	5,842 (2,650)	7,099 (3,220)	4,519 (2,050)				5,578 (2,530)*	3,682 (1,670)	22-9 (6,926)
-3-3 (-1)	10,670 (4,840)*	10,670 (4,840)*	20,084 (9,110)*	12,147 (5,510)	12,919 (5,860)	8,047 (3,650)	9,149 (4,150)	5,732 (2,600)	7,033 (3,190)	4,453 (2,020)				6,129 (2,780)	3,902 (1,770)	21-9 (6,623)
-6-7 (-2)	16,535 (7,500)*	16,535 (7,500)*	21,539 (9,770)	12,192 (5,530)	12,897 (5,850)	7,826 (3,550)	9,127 (4,140)	5,710 (2,590)	7,033 (3,190)	4,475 (2,030)				6,834 (3,100)	4,343 (1,970)	20-2 (6,141)
-9-10 (-3)	24,119 (10,940)*	24,119 (10,940)*	20,040 (9,090)*	12,346 (5,600)	12,985 (5,890)	7,915 (3,590)	9,215 (4,180)	5,776 (2,620)						8,201 (3,720)	5,203 (2,360)	17-10 (5,435)

LIFT CAPACITIES – DIPPER LENGTH: 8'2" (2.5 m), 15'5" (4.7 m) MONOBOOM, TRACKSHOES: 20" (500 mm), NO BUCKET, DOZER **JZ141 LC MONO**

Reach ft-in (m)	6-7 (2)		9-10 (3)		13-1 (4)		16-5 (5)		19-8 (6)		23-0 (7)		Capacity at Max Reach			
																ft-in (mm)
Load Point Ht.	lb (kg)	lb (kg)	lb (kg)	lb (kg)	lb (kg)	lb (kg)	lb (kg)	lb (kg)	lb (kg)	lb (kg)	lb (kg)	lb (kg)	lb (kg)	lb (kg)	lb (kg)	ft-in (mm)
19-8 (6)					7,606 (3,450)*	7,606 (3,450)*	8,069 (3,660)*	7,341 (3,330)						5,203 (2,360)*	5,203 (2,360)*	18-0 (5,490)
16-5 (5)					8,091 (3,670)*	8,091 (3,670)*	8,201 (3,720)*	7,319 (3,320)	6,548 (2,970)*	5,379 (2,440)				4,894 (2,220)*	4,894 (2,220)*	20-3 (6,179)
13-1 (4)			10,406 (4,720)*	10,406 (4,720)*	9,436 (4,280)*	9,436 (4,280)*	8,885 (4,030)*	7,165 (3,250)	8,135 (3,690)	5,335 (2,420)				4,762 (2,160)*	4,475 (2,030)	21-10 (6,648)
9-10 (3)			14,462 (6,560)*	14,462 (6,560)*	11,442 (5,190)*	9,700 (4,400)	9,965 (4,520)*	6,923 (3,140)	5,798 (2,630)	5,225 (2,370)				4,762 (2,160)*	4,101 (1,860)	22-9 (6,941)
6-7 (2)			18,982 (8,610)*	14,088 (6,390)	13,691 (6,210)*	9,171 (4,160)	10,340 (4,690)	6,636 (3,010)	7,826 (3,550)	5,071 (2,300)	6,063 (2,750)*	3,990 (1,810)		4,894 (2,220)*	3,902 (1,770)	23-3 (7,080)
3-3 (1)			14,881 (6,750)*	13,294 (6,030)	14,198 (6,440)	8,730 (3,960)	10,053 (4,560)	6,371 (2,890)	7,672 (3,480)	4,916 (2,230)	6,107 (2,770)	3,902 (1,770)		5,137 (2,330)*	3,858 (1,750)	23-3 (7,076)
0-0 (0)			15,631 (7,090)*	12,941 (5,870)	13,867 (6,290)	8,444 (3,830)	9,833 (4,460)	6,173 (2,800)	7,540 (3,420)	4,806 (2,180)				5,578 (2,530)*	3,924 (1,780)	22-9 (6,926)
-3-3 (-1)	10,670 (4,840)*	10,670 (4,840)*	20,084 (9,110)*	12,831 (5,820)	13,691 (6,210)	8,311 (3,770)	9,722 (4,410)	6,063 (2,750)	7,474 (3,390)	4,740 (2,150)				6,217 (2,820)*	4,145 (1,880)	21-9 (6,623)
-6-7 (-2)	16,535 (7,500)*	16,535 (7,500)*	22,090 (10,020)*	12,875 (5,840)	13,669 (6,200)	8,289 (3,760)	9,700 (4,400)	6,041 (2,740)	7,474 (3,390)	4,740 (2,150)				7,253 (3,290)	4,608 (2,090)	20-2 (6,141)
-9-10 (-3)	24,119 (10,940)*	24,119 (10,940)*	20,040 (9,090)*	13,051 (5,920)	13,779 (6,250)	8,378 (3,800)	9,789 (4,440)	6,129 (2,780)						8,708 (3,950)	5,512 (2,500)	17-10 (5,435)

LIFT CAPACITIES – DIPPER LENGTH: 8'2" (2.5 m), 15'5" (4.7 m) MONOBOOM, TRACKSHOES: 24" (500 mm), NO BUCKET **JZ141 HD MONO**

Reach ft-in (m)	6-7 (2)		9-10 (3)		13-1 (4)		16-5 (5)		19-8 (6)		23-0 (7)		Capacity at Max Reach			
																ft-in (mm)
Load Point Ht.	lb (kg)	lb (kg)	lb (kg)	lb (kg)	lb (kg)	lb (kg)	lb (kg)	lb (kg)	lb (kg)	lb (kg)	lb (kg)	lb (kg)	lb (kg)	lb (kg)	lb (kg)	ft-in (mm)
19-8 (6)					7,606 (3,450)*	7,606 (3,450)*	8,069 (3,660)*	8,069 (3,660)*						5,203 (2,360)*	5,203 (2,360)*	18-0 (5,490)
16-5 (5)					8,091 (3,670)*	8,091 (3,670)*	8,201 (3,720)*	8,201 (3,720)*	6,548 (2,970)*	6,460 (2,930)				4,894 (2,220)*	4,894 (2,220)*	20-3 (6,179)
13-1 (4)			10,406 (4,720)*	10,406 (4,720)*	9,436 (4,280)*	9,436 (4,280)*	8,885 (4,030)*	8,576 (3,890)	8,620 (3,910)*	6,415 (2,910)				4,762 (2,160)*	4,762 (2,160)*	21-10 (6,648)
9-10 (3)			14,462 (6,560)*	14,462 (6,560)*	11,442 (5,190)*	11,442 (5,190)*	9,965 (4,520)*	8,311 (3,770)	8,973 (4,070)	6,283 (2,850)				4,762 (2,160)*	4,762 (2,160)*	22-9 (6,941)
6-7 (2)			18,982 (8,610)*	17,505 (7,940)	13,691 (6,210)*	11,177 (5,070)	11,222 (5,090)*	8,025 (3,640)	8,796 (3,990)	6,129 (2,780)	6,063 (2,750)*	4,850 (2,200)		4,850 (2,220)*	4,762 (2,160)	23-3 (7,080)
3-3 (1)			14,881 (6,750)*	14,881 (6,750)*	15,609 (7,080)*	10,714 (4,860)	11,354 (5,150)	7,760 (3,520)	8,620 (3,910)	5,975 (2,710)	6,371 (2,890)*	4,762 (2,160)		5,137 (2,330)*	4,696 (2,130)	23-3 (7,076)
0-0 (0)			15,631 (7,090)*	15,631 (7,090)*	15,873 (7,200)	10,406 (4,720)	11,133 (5,050)	7,562 (3,430)	7,893 (3,580)	5,864 (2,660)				5,578 (2,530)*	4,784 (2,170)	22-9 (6,926)
-3-3 (-1)	10,670 (4,840)*	10,670 (4,840)*	20,084 (9,110)*	16,182 (7,340)	15,697 (7,120)	10,251 (4,650)	11,023 (5,000)	7,452 (3,380)	8,422 (3,820)	5,776 (2,620)				6,217 (2,820)*	5,071 (2,300)	21-9 (6,623)
-6-7 (-2)	16,535 (7,500)*	16,535 (7,500)*	22,090 (10,020)*	16,226 (7,360)	15,675 (7,110)	10,229 (4,640)	10,979 (4,980)	7,430 (3,370)	8,444 (3,830)	5,798 (2,630)				7,319 (3,320)*	5,644 (2,560)	20-2 (6,141)
-9-10 (-3)	24,119 (10,940)*	24,119 (10,940)*	20,040 (9,090)*	16,402 (7,440)	15,410 (6,990)*	10,340 (4,690)	11,089 (5,030)	7,518 (3,410)						9,370 (4,250)*	6,724 (3,050)	17-10 (5,435)



Lift capacity front and rear.















Notes:

1. For lifting capacity including bucket, subtract total weight of bucket or bucket and quickhitch from above values.
2. Lifting capacities are based on ISO 10567, that is: 75% of minimum tipping load or 87% of hydraulic lift capacity, whichever is the less. Lifting capacities marked* are based on hydraulic capacity.
3. Lift capacities assume that the machine is on firm, level ground.
4. Lift capacities may be limited by local regulations. Please refer to your dealer.

















Lift capacity full circle.















LIFT CAPACITIES – DIPPER LENGTH: 8'10" (2.7m), 15'5" (4.7 m) MONOBOOM, TRACKSHOES: 20" (500 mm), NO BUCKET **JZ141 LC MONO**

Reach ft-in (m)	6-7 (2)		9-10 (3)		13-1 (4)		16-5 (5)		19-8 (6)		23-0 (7)		Capacity at Max Reach		ft-in (mm)	
																
Load Point Ht.	lb (kg)	lb (kg)	lb (kg)	lb (kg)	lb (kg)	lb (kg)	lb (kg)	lb (kg)	lb (kg)	lb (kg)	lb (kg)	lb (kg)	lb (kg)	lb (kg)	lb (kg)	
19-8 (6)					7,055 (3,200)*	7,055 (3,200)*	7,672 (3,480)*	7,077 (3,210)						5,445 (2,470)*	5,445 (2,470)*	18- 9 (5,720)
16-5 (5)					7,562 (3,430)*	7,562 (3,430)*	7,782 (3,530)*	7,033 (3,190)	7,562 (3,430)*	5,159 (2,340)				5,159 (2,340)*	4,586 (2,080)	20- 11 (6,384)
13-1 (4)					8,885 (4,030)*	8,885 (4,030)*	8,466 (3,840)*	6,856 (3,110)	7,716 (3,500)	5,093 (2,310)				5,049 (2,290)*	4,034 (1,830)	22- 5 (6,839)
9-10 (3)			13,470 (6,110)*	13,470 (6,110)*	10,891 (4,940)*	9,304 (4,220)	9,590 (4,350)*	6,592 (2,990)	7,584 (3,440)	4,960 (2,250)	5,908 (2,680)	3,836 (1,740)		5,049 (2,290)*	3,704 (1,680)	23- 4 (7,124)
6-7 (2)			18,034 (8,180)*	13,536 (6,140)	13,184 (5,980)*	8,774 (3,980)	9,789 (4,440)	6,305 (2,860)	7,408 (3,360)	4,784 (2,170)	5,820 (2,640)	3,748 (1,700)		5,181 (2,350)*	3,527 (1,600)	23- 10 (7,260)
3-3 (1)			16,667 (7,560)*	16,632 (7,570)	13,426 (6,090)	8,289 (3,760)	9,502 (4,310)	6,019 (2,730)	7,209 (3,270)	4,630 (2,100)	5,732 (2,600)	3,660 (1,660)		5,423 (2,460)	3,461 (1,570)	23- 10 (7,255)
0-0 (0)			16,072 (7,290)*	12,192 (5,530)	13,051 (5,920)	7,959 (3,610)	9,259 (4,200)	5,820 (2,640)	7,077 (3,210)	4,497 (2,040)	5,666 (2,570)	3,594 (1,630)		5,534 (2,510)	3,527 (1,600)	23- 4 (7,110)
-3-3 (- 1)	10,362 (4,700)*	10,362 (4,700)*	19,753 (8,960)*	12,037 (5,460)	12,853 (5,830)	7,782 (3,530)	9,105 (4,130)	5,688 (2,580)	6,989 (3,170)	4,409 (2,000)				5,842 (2,650)	3,704 (1,680)	22- 4 (6,814)
-6-7 (- 2)	15,719 (7,130)*	15,719 (7,130)*	21,407 (9,710)	12,059 (5,470)	12,809 (5,810)	7,738 (3,510)	9,061 (4,110)	5,644 (2,560)	6,989 (3,170)	4,409 (2,000)				6,460 (2,930)	4,101 (1,860)	20- 10 (6,348)
-9-10 (- 3)	22,686 (10,290)*	22,686 (10,290)*	20,525 (9,310)*	12,214 (5,540)	12,897 (5,850)	7,826 (3,550)	9,127 (4,140)	5,710 (2,590)						7,672 (3,480)	4,850 (2,200)	18- 7 (5,667)

LIFT CAPACITIES – DIPPER LENGTH: 8'10" (2.7m), 15'5" (4.7 m) MONOBOOM, TRACKSHOES: 20" (500 mm), NO BUCKET, DOZER **JZ141 LC MONO**

Reach ft-in (m)	6-7 (2)		9-10 (3)		13-1 (4)		16-5 (5)		19-8 (6)		23-0 (7)		Capacity at Max Reach		ft-in (mm)	
																
Load Point Ht.	lb (kg)	lb (kg)	lb (kg)	lb (kg)	lb (kg)	lb (kg)	lb (kg)	lb (kg)	lb (kg)	lb (kg)	lb (kg)	lb (kg)	lb (kg)	lb (kg)	lb (kg)	
19-8 (6)					7,055 (3,200)*	7,055 (3,200)*	7,672 (3,480)*	7,430 (3,370)						5,445 (2,470)*	5,445 (2,470)*	18- 9 (5,720)
16-5 (5)					7,562 (3,430)*	7,562 (3,430)*	7,782 (3,530)*	7,385 (3,350)	7,562 (3,430)*	5,445 (2,470)				5,159 (2,340)*	4,850 (2,200)	20- 11 (6,384)
13-1 (4)					8,885 (4,030)*	8,885 (4,030)*	8,466 (3,840)*	7,209 (3,270)	8,157 (3,700)	5,379 (2,440)				5,049 (2,290)*	4,277 (1,940)	22- 5 (6,839)
9-10 (3)			13,470 (6,110)*	13,470 (6,110)*	10,891 (4,940)*	9,789 (4,440)	9,590 (4,350)*	6,945 (3,150)	8,025 (3,640)	5,225 (2,370)	6,261 (2,840)	4,057 (1,840)		5,049 (2,290)*	3,946 (1,790)	23- 4 (7,124)
6-7 (2)			18,034 (8,180)*	14,242 (6,460)	13,184 (5,980)*	9,237 (4,190)	10,362 (4,700)	6,658 (3,020)	7,848 (3,560)	5,071 (2,300)	6,195 (2,810)	3,990 (1,810)		5,181 (2,350)*	3,748 (1,700)	23- 10 (7,260)
3-3 (1)			16,667 (7,560)*	13,338 (6,050)	14,220 (6,450)	8,752 (3,970)	10,053 (4,560)	6,371 (2,890)	7,672 (3,480)	4,916 (2,230)	6,085 (2,760)	3,902 (1,770)		5,445 (2,470)*	3,682 (1,670)	23- 10 (7,255)
0-0 (0)			16,072 (7,290)*	12,897 (5,850)	13,845 (6,280)	8,422 (3,820)	9,833 (4,460)	6,151 (2,790)	7,518 (3,410)	4,784 (2,170)	6,019 (2,730)	3,836 (1,740)		5,864 (2,660)*	3,748 (1,700)	23- 4 (7,110)
-3-3 (- 1)	10,362 (4,700)*	10,362 (4,700)*	19,753 (8,960)*	12,743 (5,780)	13,647 (6,190)	8,245 (3,740)	9,678 (4,390)	6,041 (2,740)	7,430 (3,370)	4,696 (2,130)				6,217 (2,820)	3,946 (1,790)	22- 4 (6,814)
-6-7 (- 2)	15,719 (7,130)*	15,719 (7,130)*	22,333 (10,130)*	12,765 (5,790)	13,603 (6,170)	8,201 (3,720)	9,634 (4,370)	5,997 (2,720)	7,430 (3,370)	4,674 (2,120)				6,878 (3,120)	4,365 (1,980)	20- 10 (6,348)
-9-10 (- 3)	22,686 (10,290)*	22,686 (10,290)*	20,525 (9,310)*	12,919 (5,860)	13,691 (6,210)	8,289 (3,760)	9,700 (4,400)	6,041 (2,740)						8,135 (3,690)	5,159 (2,340)	18- 7 (5,667)

LIFT CAPACITIES – DIPPER LENGTH: 8'10" (2.7 m), 15'5" (4.7 m) MONOBOOM, TRACKSHOES: 24" (500 mm), NO BUCKET **JZ141 HD MONO**



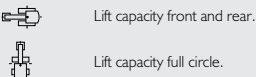











Reach ft-in (m)	6-7 (2)		9-10 (3)		13-1 (4)		16-5 (5)		19-8 (6)		23-0 (7)		Capacity at Max Reach		ft-in (mm)	
																
Load Point Ht.	lb (kg)	lb (kg)	lb (kg)	lb (kg)	lb (kg)	lb (kg)	lb (kg)	lb (kg)	lb (kg)	lb (kg)	lb (kg)	lb (kg)	lb (kg)	lb (kg)	lb (kg)	
19-8 (6)					7,055 (3,200)*	7,055 (3,200)*	7,672 (3,480)*	7,672 (3,480)*						5,445 (2,470)*	5,445 (2,470)*	18- 9 (5,720)
16-5 (5)					7,562 (3,430)*	7,562 (3,430)*	7,782 (3,530)*	7,782 (3,530)*	7,562 (3,430)*	6,504 (2,950)				5,159 (2,340)*	5,159 (2,340)*	20- 11 (6,384)
13-1 (4)					8,885 (4,030)*	8,885 (4,030)*	8,466 (3,840)*	8,466 (3,840)*	8,267 (3,750)*	6,437 (2,920)				5,049 (2,290)*	5,049 (2,290)*	22- 5 (6,839)
9-10 (3)			13,470 (6,110)*	13,470 (6,110)*	10,891 (4,940)*	10,891 (4,940)*	9,590 (4,350)*	8,356 (3,790)	8,863 (4,020)*	6,305 (2,860)	6,349 (2,880)*	4,916 (2,230)		5,049 (2,290)*	4,784 (2,170)	23- 4 (7,124)
6-7 (2)			18,034 (8,180)*	17,659 (8,010)	13,184 (5,980)*	11,222 (5,090)	10,869 (4,930)*	8,047 (3,650)	8,796 (3,990)	6,129 (2,780)	6,945 (3,150)	4,850 (2,200)		5,181 (2,350)*	4,564 (2,070)	23- 10 (7,260)
3-3 (1)			16,667 (7,560)*	16,667 (7,560)*	15,212 (6,900)*	10,737 (4,870)	11,376 (5,160)	7,760 (3,520)	8,620 (3,910)	5,975 (2,710)	6,834 (3,100)	4,762 (2,160)		5,445 (2,470)*	4,497 (2,040)	23- 10 (7,255)
0-0 (0)			16,072 (7,290)*	16,072 (7,290)*	15,851 (7,190)	10,384 (4,710)	11,133 (5,050)	7,540 (3,420)	8,466 (3,840)	5,842 (2,650)	6,768 (3,070)	4,696 (2,130)		5,864 (2,660)*	4,586 (2,080)	23- 4 (7,110)
-3-3 (- 1)	10,362 (4,700)*	10,362 (4,700)*	19,753 (8,960)*	16,072 (7,290)	15,653 (7,100)	10,207 (4,630)	10,979 (4,980)	7,408 (3,360)	8,378 (3,800)	5,754 (2,610)				6,548 (2,970)*	4,850 (2,200)	22- 4 (6,814)
-6-7 (- 2)	15,719 (7,130)*	15,719 (7,130)*	22,333 (10,130)*	16,094 (7,300)	15,587 (7,070)	10,163 (4,610)	10,935 (4,960)	7,363 (3,340)	8,378 (3,800)	5,732 (2,600)				7,606 (3,450)*	5,335 (2,420)	20- 10 (6,348)
-9-10 (- 3)	22,686 (10,290)*	22,686 (10,290)*	20,525 (9,310)*	16,248 (7,370)	15,675 (7,110)	10,229 (4,640)	11,001 (4,990)	7,430 (3,370)						9,193 (4,170)	6,305 (2,860)	18- 7 (5,667)

















Notes:

1. For lifting capacity including bucket, subtract total weight of bucket or bucket and quickhitch from above values.
2. Lifting capacities are based on ISO 10567, that is: 75% of minimum tipping load or 87% of hydraulic lift capacity, whichever is the less. Lifting capacities marked* are based on hydraulic capacity.
3. Lift capacities assume that the machine is on firm, level ground.
4. Lift capacities may be limited by local regulations. Please refer to your dealer.















LIFT CAPACITIES – DIPPER LENGTH: 9'10" (3.0 m), 15'5" (4.7 m) MONOBOOM, TRACKSHOES: 20" (500 mm), NO BUCKET **JZ141 LC MONO**

Reach ft-in(m)	6-7 (2)		9-10 (3)		13-1 (4)		16-5 (5)		19-8 (6)		23-0 (7)		Capacity at Max Reach		ft-in (mm)
	 lb (kg)	 lb (kg)	 lb (kg)	 lb (kg)	 lb (kg)	 lb (kg)	 lb (kg)	 lb (kg)	 lb (kg)	 lb (kg)	 lb (kg)	 lb (kg)	 lb (kg)	 lb (kg)	
Load Point Ht.															
6.0m							6,945 (3,150)	6,945 (3,150)	5,247 (2,380)*	5,181 (2,350)			4,762 (2,160)*	4,762 (2,160)*	19- 11 (6,070)
5.0m							7,121 (3,230)	7,121 (3,220)	7,408 (3,360)*	5,225 (2,370)			4,519 (2,050)*	4,255 (1,930)	22- 0 (6,699)
4.0m					8,047 (3,650)*	8,047 (3,650)*	7,871 (3,570)	6,923 (3,140)	7,760 (3,520)*	5,137 (2,330)	5,490 (2,490)*	3,902 (1,770)	4,431 (2,010)*	3,770 (1,710)	23- 5 (7,133)
3.0m			11,993 (5,440)*	11,993 (5,440)*	10,053 (4,560)*	9,436 (4,280)	9,017 (4,090)	6,658 (3,020)	7,606 (3,450)	4,982 (2,260)	5,930 (2,690)	3,858 (1,750)	4,453 (2,020)*	3,483 (1,580)	24- 4 (7,407)
2.0m			16,623 (7,540)*	13,823 (6,270)	12,412 (5,630)*	8,863 (4,020)	9,855 (4,470)	6,349 (2,880)	7,408 (3,360)	4,806 (2,180)	5,820 (2,640)	3,748 (1,700)	4,564 (2,070)*	3,307 (1,500)	24- 9 (7,538)
1.0m			20,437 (9,270)*	12,787 (5,800)	13,514 (6,130)	8,356 (3,790)	9,524 (4,320)	6,041 (2,740)	7,231 (3,280)	4,630 (2,100)	5,710 (2,590)	3,660 (1,660)	4,784 (2,170)*	3,241 (1,470)	24- 9 (7,533)
0m			17,218 (7,810)*	12,214 (5,540)	13,073 (5,930)	7,981 (3,620)	9,259 (4,200)	5,798 (2,630)	7,055 (3,200)	4,475 (2,030)	5,622 (2,550)	3,571 (1,620)	5,137 (2,330)*	3,285 (1,490)	24- 3 (7,393)
- 1.0m	10,185 (4,620)*	10,185 (4,620)*	19,511 (8,850)*	11,993 (5,440)	12,831 (5,820)	7,760 (3,520)	9,083 (4,120)	5,644 (2,560)	6,945 (3,150)	4,365 (1,980)	5,578 (2,530)	3,527 (1,600)	5,467 (2,480)	3,461 (1,570)	23- 4 (7,110)
- 2.0m	14,683 (6,660)*	14,683 (6,660)*	21,275 (9,650)	11,949 (5,420)	12,743 (5,780)	7,672 (3,480)	8,995 (4,080)	5,578 (2,530)	6,923 (3,140)	4,343 (1,970)			5,975 (2,710)	3,770 (1,710)	21- 10 (6,664)
- 3.0m	20,525 (9,310)*	20,525 (9,310)*	21,186 (9,610)*	12,059 (5,470)	12,787 (5,800)	7,716 (3,500)	9,039 (4,100)	5,600 (2,540)	6,989 (3,170)	4,409 (2,000)			6,967 (3,160)	4,387 (1,990)	19- 9 (6,020)

LIFT CAPACITIES – DIPPER LENGTH: 9'10" (3.0 m), 15'5" (4.7 m) MONOBOOM, TRACKSHOES: 20" (500 mm), NO BUCKET, DOZER **JZ141 LC MONO**

Reach ft-in(m)	6-7 (2)		9-10 (3)		13-1 (4)		16-5 (5)		19-8 (6)		23-0 (7)		Capacity at Max Reach		ft-in (mm)
	 lb (kg)	 lb (kg)	 lb (kg)	 lb (kg)	 lb (kg)	 lb (kg)	 lb (kg)	 lb (kg)	 lb (kg)	 lb (kg)	 lb (kg)	 lb (kg)	 lb (kg)	 lb (kg)	
Load Point Ht.															
6.0m							6,945 (3,150)*	6,945 (3,150)*	5,247 (2,380)*	5,247 (2,380)*			4,762 (2,160)*	4,762 (2,160)*	19- 11 (6,070)
5.0m							7,121 (3,230)*	7,121 (3,230)*	7,408 (3,360)*	5,490 (2,490)			4,519 (2,050)*	4,497 (2,040)	22- 0 (6,699)
4.0m					8,047 (3,650)*	8,047 (3,650)*	7,871 (3,570)*	7,275 (3,300)	7,760 (3,520)*	5,401 (2,450)	5,490 (2,490)*	4,145 (1,880)	4,431 (2,010)*	3,990 (1,810)	23- 5 (7,133)
3.0m			11,993 (5,440)*	11,993 (5,440)*	10,053 (4,560)*	9,899 (4,490)	9,017 (4,090)*	7,011 (3,180)	8,047 (3,650)	5,269 (2,390)	6,283 (2,850)	4,079 (1,850)	4,453 (2,020)*	3,682 (1,670)	24- 4 (7,407)
2.0m			16,623 (7,540)*	14,528 (6,590)	12,412 (5,630)*	9,326 (4,230)	10,362 (4,700)*	6,702 (3,040)	7,871 (3,570)	5,093 (2,310)	6,195 (2,810)	3,990 (1,810)	4,564 (2,070)*	3,527 (1,600)	24- 9 (7,538)
1.0m			20,437 (9,270)*	13,492 (6,120)	14,308 (6,490)	8,818 (4,000)	10,097 (4,580)	6,393 (2,900)	7,672 (3,480)	4,894 (2,220)	6,085 (2,760)	3,880 (1,760)	4,784 (2,170)*	3,461 (1,570)	24- 9 (7,533)
0m			17,218 (7,810)*	12,919 (5,860)	13,867 (6,290)	8,444 (3,830)	9,833 (4,460)	6,151 (2,790)	7,496 (3,400)	4,762 (2,160)	5,997 (2,720)	3,792 (1,720)	5,137 (2,330)*	3,505 (1,590)	24- 3 (7,393)
- 1.0m	10,185 (4,620)*	10,185 (4,620)*	19,511 (8,850)*	12,699 (5,760)	13,625 (6,180)	8,223 (3,730)	9,656 (4,380)	5,997 (2,720)	7,385 (3,350)	4,652 (2,110)	5,952 (2,700)	3,748 (1,700)	5,666 (2,570)*	3,682 (1,670)	23- 4 (7,110)
- 2.0m	14,683 (6,660)*	14,683 (6,660)*	22,575 (10,240)	12,655 (5,740)	13,536 (6,140)	8,135 (3,690)	9,568 (4,340)	5,930 (2,690)	7,363 (3,340)	4,608 (2,090)			6,371 (2,890)	4,012 (1,820)	21- 10 (6,664)
- 3.0m	20,525 (9,310)*	20,525 (9,310)*	21,186 (9,610)*	12,765 (5,790)	13,580 (6,160)	8,179 (3,710)	9,612 (4,360)	5,952 (2,700)	7,430 (3,370)	4,696 (2,130)			7,408 (3,360)	4,674 (2,120)	19- 9 (6,020)

LIFT CAPACITIES – DIPPER LENGTH: 9'10" (3.0 m), 15'5" (4.7 m) MONOBOOM, TRACKSHOES: 24" (500 mm), NO BUCKET **JZ141 HD MONO**

Reach ft-in(m)	6-7 (2)		9-10 (3)		13-1 (4)		16-5 (5)		19-8 (6)		23-0 (7)		Capacity at Max Reach		ft-in (mm)
	 lb (kg)	 lb (kg)	 lb (kg)	 lb (kg)	 lb (kg)	 lb (kg)	 lb (kg)	 lb (kg)	 lb (kg)	 lb (kg)	 lb (kg)	 lb (kg)	 lb (kg)	 lb (kg)	
Load Point Ht.															
6.0m							6,945 (3,150)*	6,945 (3,150)*	5,247 (2,380)*	5,247 (2,380)*			4,762 (2,160)*	4,762 (2,160)*	19- 11 (6,070)
5.0m							7,121 (3,230)*	7,121 (3,230)*	7,408 (3,360)*	6,570 (2,980)			4,519 (2,050)*	4,519 (2,050)*	22- 0 (6,699)
4.0m					8,047 (3,650)*	8,047 (3,650)*	7,871 (3,570)*	7,871 (3,570)*	7,760 (3,520)*	6,482 (2,940)	5,490 (2,490)*	5,004 (2,270)	4,431 (2,010)*	4,431 (2,010)*	23- 5 (7,133)
3.0m			11,993 (5,440)*	11,993 (5,440)*	10,053 (4,560)*	10,053 (4,560)*	9,017 (4,090)*	8,422 (3,820)	8,400 (3,810)*	6,327 (2,870)	7,055 (3,200)	4,938 (2,240)	4,453 (2,020)*	4,453 (2,020)*	24- 4 (7,407)
2.0m			16,623 (7,540)*	16,623 (7,540)*	12,412 (5,630)*	11,332 (5,140)	10,362 (4,700)*	8,091 (3,670)	8,818 (4,000)	6,151 (2,790)	6,945 (3,150)*	4,850 (2,200)	4,564 (2,070)*	4,299 (1,950)	24- 9 (7,538)
1.0m			20,437 (9,270)*	16,887 (7,660)	14,573 (6,610)*	10,803 (4,900)	11,398 (5,170)	7,782 (3,530)	8,620 (3,910)	5,975 (2,710)	6,834 (3,100)*	4,740 (2,150)	4,784 (2,170)*	4,233 (1,920)	24- 9 (7,533)
0m			17,218 (7,810)*	16,270 (7,380)	15,873 (7,200)	10,406 (4,720)	11,133 (5,050)	7,540 (3,420)	8,466 (3,840)	5,820 (2,640)	6,746 (3,060)	4,652 (2,110)	5,137 (2,330)*	4,299 (1,950)	24- 3 (7,393)
- 1.0m	10,185 (4,620)*	10,185 (4,620)*	19,511 (8,850)*	16,028 (7,270)	15,609 (7,080)	10,185 (4,620)	10,935 (4,960)	7,363 (3,340)	8,356 (3,790)	5,710 (2,590)	6,702 (3,040)	4,608 (2,090)	5,666 (2,570)*	4,519 (2,050)	23- 4 (7,110)
- 2.0m	14,683 (6,660)*	14,683 (6,660)*	22,641 (10,270)*	15,984 (7,250)	15,521 (7,040)	10,097 (4,580)	10,869 (4,930)	7,297 (3,310)	8,311 (3,770)	5,666 (2,570)			6,548 (2,970)*	4,938 (2,240)	21- 10 (6,664)
- 3.0m	20,525 (9,310)*	20,525 (9,310)*	21,186 (9,610)*	16,094 (7,300)	15,565 (7,060)	10,141 (4,600)	10,891 (4,940)	7,341 (3,330)	8,378 (3,800)	5,754 (2,610)			8,047 (3,650)*	5,710 (2,590)	19- 9 (6,020)

 Lift capacity front and rear. **Notes:**

 Lift capacity full circle.

1. For lifting capacity including bucket, subtract total weight of bucket or bucket and quickhitch from above values.
2. Lifting capacities are based on ISO 10567, that is: 75% of minimum tipping load or 87% of hydraulic lift capacity, whichever is the less. Lifting capacities marked* are based on hydraulic capacity.
3. Lift capacities assume that the machine is on firm, level ground.
4. Lift capacities may be limited by local regulations. Please refer to your dealer.





ONE COMPANY, MORE THAN 300 MACHINES.

TRACKED EXCAVATOR JZ141 LC/HD

Gross engine power: 74 hp (55 kW)

Bucket capacity: 0.46–1.16 yd³ Operating weight: 33,301–39,593 lbs

JCB North America

2000 Bamford Blvd., Pooler, Georgia, 31322 Tel: (912) 447-2000

Download the very latest information on this product range at www.jcb.com

JCB inc. All rights reserved. No part of this publication may be reproduced, stored in a retrieval system, or transmitted in any form or by any other means, electronic, mechanical, photocopying or otherwise, without prior permission from JCB inc. All references in this publication to operating weights, sizes, capacities and other performance measurements are provided for guidance only and may vary dependant upon the exact specification of machine. They should not therefore be relied upon in relation to suitability for a particular application. Guidance and advice should always be sought from your JCB Dealer. JCB reserves the right to change specifications without notice. Illustrations and specifications shown may include optional equipment and accessories. The JCB logo is a registered trademark of J.C. Bamford Excavators Ltd.

Your nearest JCB Dealer

9999/6014 01/18 en-US Issue 6 DWUSA 4714

[f /JCBNA](https://www.facebook.com/JCBNA)
[t /JCBNA](https://www.tumblr.com/JCBNA)
[v /JCBNORTHAMERICA](https://www.youtube.com/JCBNORTHAMERICA)

