

KOBELCO

Hydraulic Excavator

SK230SRLC

SK230SRLC-5

DRIVEN BY PASSION

■ Bucket Capacity :

0.63 - 1.60 cu. yd. SAE

■ Engine Power :

160 hp {119 kW} @ 2,000 rpm
(SAE NET)

■ Operating Weight :

56,400 lbs {25,600 kg}



Note: This document may contain attachments and optional equipment that are not available in your area. It may also contain photographs of machines with specifications that differ from those sold in your area. Please contact your nearest KOBELCO dealer for items you require.
Due to our policy of continuous product improvement, all designs and specifications are subject to change without advance notice.
Copyright **KOBELCO CONSTRUCTION MACHINERY CO., LTD.** No part of this document may be reproduced in any manner without prior written permission from KOBELCO.

KOBELCO CONSTRUCTION MACHINERY U.S.A. INC.

22350 Merchants Way, Katy, Texas 77449
<http://www.kobelco-usa.com/>

Inquiries To:

Bulletin No. SK230SRLC-NA-101-160500N

Complies with the latest exhaust emission regulations



US EPA
Tier IV Final



EU (NRMM)
Stage IV



Japanese
Regulations

Power Meets Efficiency

With iNDr for even quieter operation.

SK230SR_{LC}



“KOBELCO has made the short rear swing excavator the standard for mid-sized machines. And with ongoing development in innovations such as the iNDr noise reduction system that both shuts out indr filters dust and cuts noise, KOBELCO is boosting value and leading the industry with construction machinery ideally suited to the urban environment.

The new SK230SR_{LC} retains the compact shape and iNDr system advantages that KOBELCO has pioneered, but it has been fitted with a new engine assembly for improved environmental protection. Low fuel consumption is balanced against increased work performance, and machine durability has been advanced.

The new worldwide-model SK230SR_{LC}. Working for the planet.”



Low Noise and Easy Maintenance Mean Greater Value Than Ever A New Design Approach Leads to a Revolutionary Double Offset Duct Structure

By reviewing the iNDR configuration, Kobelco achieved both great visibility and a compelling design even though the engine compartment has been enlarged to meet TIER IV Final standards, maintaining the value of iNDR.

iNDR absorbs sound energy by utilizing the engine cooling duct paths of air to minimize noise levels. The new model is equipped with a selective catalytic reduction (SCR) unit, which required a new design with two offset ducts on top. This allows ample space to absorb engine noise, making these new excavators as quiet as previous SR models.



Wide, clear view to the rear

Even with the larger engine compartment, the design minimizes hood height, ensuring an excellent direct view to the rear. In addition, the operator can monitor conditions behind the machine with clear, wide-angle images from the rear-view camera, which comes as standard equipment.



The Results Are Exceptional. The Big Merits:

"Ultimate Low Noise" is achieved by minimizing sound leakage during operation

Kobelco's "Ultimate Low Noise" system exceeds all noise standards. Noise from the engine and cooling fan is absorbed by the duct, reducing machine's noise signature to the lowest in the industry. Perfect for urban utility renewal projects.



Eliminating dust maintains cooling system performance

The high-density 60-mesh* filters dust in the intake air. This prevents clogging of the cooling system and the air cleaner, which maintains peak performance. The waveform filter allows air through the tops of the waves while collecting dust at the bottom, ensuring a smooth airflow.

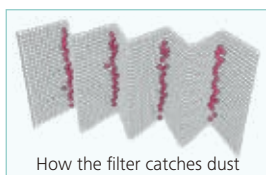

* "60-mesh" means that there are 60 holes formed by horizontal and vertical wires in every square inch of filter.



Easy filter maintenance system simplifies cleaning

Daily inspection consists of a visual check of the iNDR filter only. If it looks dirty, it can be removed and washed without special tools.



NOx emissions cut:

New, Environmentally Friendly Engine

SCR System with DEF **NEW**

Engine exhaust system utilizes Selective Catalytic Reduction (SCR) to convert NOx* into harmless nitrogen and water emissions. SCR combined with a Diesel Particulate Filter (DPF) makes the SK230SRLC a much cleaner machine meeting US EPA regulations for Tier IV final.

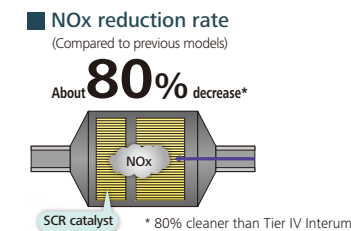
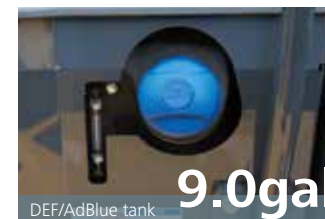

EGR cooler reduces NOx

Cooled exhaust gases from the EGR cooler are mixed with fresh air in the intake. The recirculated air lowers the combustion temperature which reduces NOx.

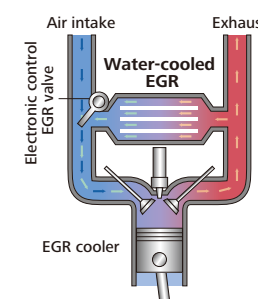

Reduces fuel consumption and minimizes exhaust emissions

The HINO engine, (a subsidiary of Toyota) is renowned for fuel efficiency and environmental performance, and KOBELCO has tuned them specifically for construction machinery.

The high-pressure common rail fuel injection system, the variable-geometry (VG) turbocharger, reduce particulate matter (PM) while the large EGR cooler greatly reduces the formation of nitrogen oxide (NOx) gases.



PM emissions cut:

Particulate matter (PM) is mostly soot resulting from incomplete combustion; Improved combustion efficiency reduces PM emissions.

Common rail system

High-pressure injection atomizes the fuel, and more precise injection improves combustion efficiency. This also contributes to better fuel economy, and engine response to work loads.

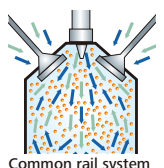

Unbeatable Performance

Greater Work Capacity:
Exceeding Expectations in Productivity

Improved Fuel Efficiency Contributes to High Performance

Superior Digging Volume

This excavator offers dynamic digging force even as it minimizes fuel consumption rates, achieving class-leading work volume. H-mode with an increased torque setting delivers about 8% greater digging volume.

■ Digging volume/hour
(Compared to H-mode on previous models)



■ Max. bucket digging force (Power Boost engaged)

29,700 lbs {132kN} (ISO 6015)

26,800 lbs {119kN} (SAE J1179)

■ Max. arm crowding force (Power Boost engaged)

21,800 lbs {96.8kN} (ISO 6015)

21,200 lbs {94.1kN} (SAE J1179)



Energy-efficient System

ECO-mode: engineered for economy

Kobelco's ECO-mode maximizes the operating efficiency of the engine and other components to achieve much greater fuel efficiency. Just press a button to choose the operation mode best suited to the task at hand and the working conditions.

■ Optimal operation with three modes

H H-mode ••• Maximum power for maximum productivity on your toughest jobs

S S-mode ••• Ideal balance of productivity and fuel efficiency for a range of urban engineering projects

E ECO-mode ••• Minimum fuel consumption for utility projects and other work that demands precision

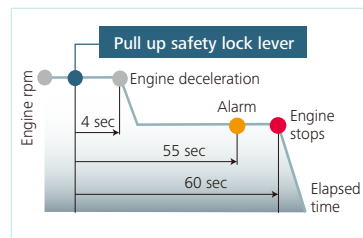

AIS (Auto Idle Stop)

If the safety lock lever is left up, the engine will stop automatically. This eliminates wasteful idling during standby, saving fuel and reducing CO₂ emissions as well.

Hydraulic system engineered to reduce energy loss

Kobelco's proprietary hydraulic systems offer hydraulic line positioning that reduces friction resistance and valves designed for higher efficiency, minimizing energy loss throughout the system.

Always and forever. Yesterday, today, and tomorrow. We're obsessed with fuel efficiency

Over the past 8 years, KOBELCO has achieved an average fuel consumption reduction of 31% across its fleet. We vow to lead the industry in improving fuel efficiency.

■ Compared to SK200SR-1S (2004)

E ECO-mode (SK230SRLC-5) ••• About **31%** improvement

Ideal for Urban Work Sites Provides a Broad Working Range, Even in Close Quarters

Minimal swing radius improves efficiency

The tail of the upper body extends 10" (250mm) past the back end of the crawlers, so the operator can concentrate on the job at hand. This also reduces the risk of collision damage.

Easy workability in less than 13' 8" of space

The compact design allows continuous 180° dig, swing, and load operations within a working space of just 13' 8".

Seamless feeling, smooth combined operations

The machines have inherited the various systems that make inching and combined operations easy and accurate. Leveling and other combined operations can be carried out with graceful ease.

Swing operation cuts cycle times

12.6rpm efficient cycle times. Dig, swing, load operations—continuous operation makes any task faster.

Heavy Lift

10% more hydraulic pressure (Heavy Lift) means greater lifting power with no time limit, for smooth and steady operation while moving heavy objects.

Power Boost

For extra power, Power Boost gives you 10% more power instantly and for as long as you need it.

■ Max. Bucket Digging Force (ISO 6015)

With Power Boost: **29,700 lbs** (132 kN)

■ Max. Arm Crowding Force (ISO 6015)

With Power Boost: **21,800 lbs** (96.8 kN)

Strong drawbar pulling force produces powerful travel capabilities

These new excavators handle steep slopes and rough roads with ease while ensuring smooth changes in direction.

Drawbar Pulling Force

Excellent drawbar force lets you conquer rough terrain and slopes.

51,500 lbs (229 kN)

Independent Travel **KOBELCO EXCLUSIVE**

Selecting Independent Travel dedicates one hydraulic pump to travel and one to the attachment on a continuous basis, allowing for a smooth and constant movement speed even while swinging or using the boom or attachment. With Independent Travel, safely carrying a large pipe across a job site is a breeze.

Excellent working range

Greater working ranges with class-topping vertical digging depth.

Max. digging height:
34'9" (10,580mm)

Max. dumping height:
25'4" (7,710mm)

Max. digging reach:
31'10" (9,700mm)

Max. vertical digging depth:
19'6" (5,950mm)

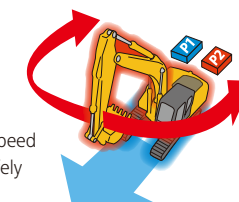
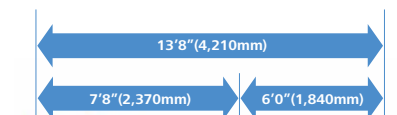
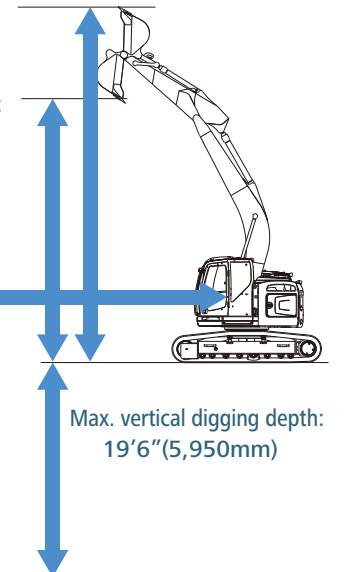

Comprehensive Safety and Intuitive Operation

User-friendly design and enhanced safety means greater efficiency and productivity.

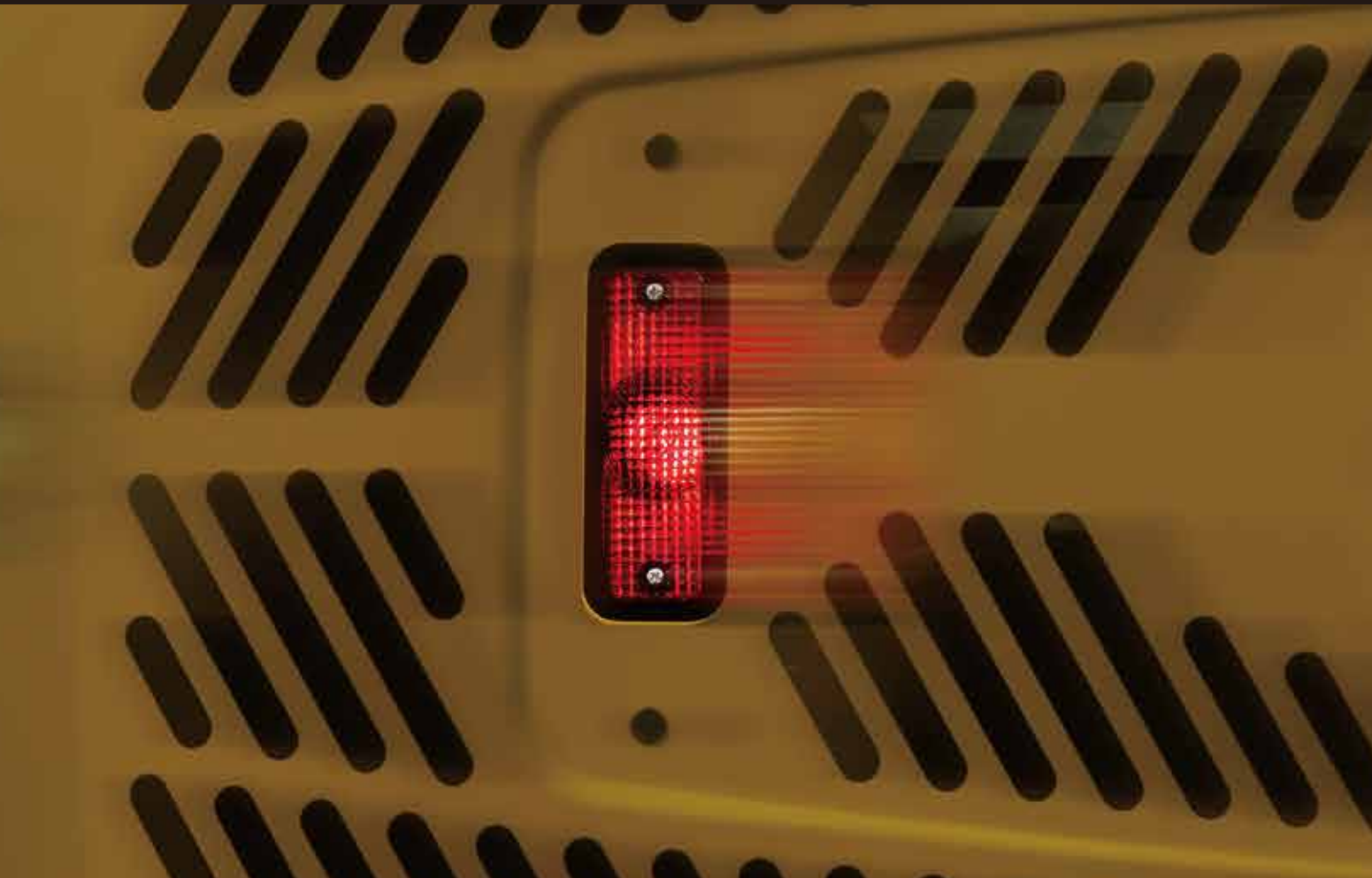

Safety

ROPS / FOPS cab

ROPS (Roll-Over-Protective Structure)-compliant cab clears ISO standards (ISO-12117-2: 2008) and ensures greater safety for the operator should the machine tip over.



Standard FOPS, Top Guard Level II. (Meets ISO10262)



Mounting brackets for vandalism guards are standard equipment (contact your KOBELCO dealer to fit vandalism or front rock guards).

Expanded field of view for greater safety



Left and right rear-view mirrors / Right bottom clearance mirror



Rear view from cab



Rear View Camera



Rear

Option right side camera NEW

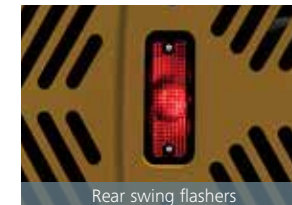

Rear swing flashers



Emergency escape hammer



Right Side Camera Monitor Rear Right

Operator-friendly Features Include Controls that Are Easy to See, Easy to Use



Multi-display in color

Brilliant colors and graphic displays are easy to recognize on the LCD multi-display in the console. The display shows fuel consumption, maintenance intervals, and more.

- 1 Analog gauge provides an intuitive reading of fuel level and engine water temperature
- 2 Green indicator light shows low fuel consumption during operation
- 3 DEF tank level gauge
- 4 Fuel consumption/Switch indicator for rear camera images
- 5 Digging mode switch
- 6 Monitor display switch

One-touch attachment mode switch

A simple flick of a switch converts the hydraulic circuit, pressure, and flow amount to match attachment changes. Icons help the operator to confirm the proper configuration at a glance.



DEF tank level gauge

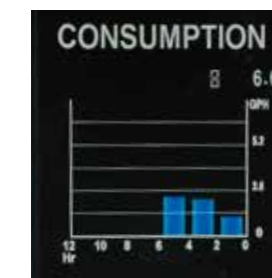

Fuel consumption

	INTERVAL	REMAINING TIME	EXCHANGE DAY
ENGINE OIL	500	495	--/--/--
FUEL FILTER	500	495	--/--/--
HYD. FILTER	1000	995	--/--/--
HYD. OIL	5000	4995	--/--/--

Maintenance



Breaker mode



Nibbler mode

Cab Design That Puts the Operator First

Wide and open, the cab's interior overflows with features that streamline operation



Standard suspension seat



Comfort

Big roomy cab

The cube design makes the most of straight lines, so the cab interior is 4% more spacious than before. Operating space literally spreads out before the operator.

Wide doors and ample head clearance mean smooth entry and exit

The control box and safety lock lever tilt up at a larger angle, and the door handle height is positioned for easy cab entry and exit.



More comfortable seat means higher productivity

The cab interior offers a host of operator comforts. The seat guarantees comfort whether on the job or at rest, and everything is ergonomically planned and laid out for smooth, stress-free operation.



Suspension seat absorbs vibration



Seat can be reclined back



Double slides allow adjustment for optimum comfort

Operator seat can be adjusted independently of the control levers, and the entire operator seat assembly can be slid forward or back.

Wide-open field of view

On the right side, the large single window has no center pillar, and the whole cab is designed for a wide field of view, giving the operator a direct view ahead and to the left and right. Mirrors in three positions make it easy for the operator to see around the machine.

Equipment designed for comfort and convenience



Bluetooth installed **NEW** radio

Bluetooth installed to allow connections with smartphones and other devices.



Powerful automatic air conditioner

Also standard is an automatic air conditioner that maintains a comfortable interior environment all year around.



Spacious storage tray



Large cup holder



USB connector



12V power outlet

Proper Maintenance Ensures Peak Efficiency

Kobelco machines are designed for quick, simple inspection and maintenance.

Machine Information Display Function

- Displays only the maintenance information that's needed, when it's needed
- Self-diagnostic function provides early-warning detection and display of any possible electrical issues
- Service-diagnostic function makes it easier to check the status of the machine
- Record function of previous maintenance issues including irregular and transient malfunction



Maintenance information display

Quality That Keeps on Shining. Valuable Assets Take Your Business to the Next Level

Structural strength and proven reliability mean these machines can deal with heavy work loads and perform in rigorous site environments. From the lifecycle viewpoint, these machines maintain their value throughout their service lives.



Easy, on-the-spot maintenance NEW



Urea tank
Urea filler cap is placed on the step for easy access.



Engine maintenance
A special lower access step, near the engine, simplifies maintenance.



Handrail
The handrail on the step side allows easy access to the maintenance port on the upper arm.

Maintenance work, daily checks, etc., can be done from ground level

The layout allows for easy access from the ground for many daily checks and regular maintenance tasks.



Engine oil filter



Fuel filter with built-in water-separator



iNDr filter/radiator reservoir tank/air cleaner access.



Control valve

Fast maintenance requires only a few procedures



Washer fluid tank is located under the cab floor mat.



Engine oil quick-drain valve can be turned without, special tools.



Fuel tank features bottom flange and large drain valve for easy maintenance.

Improved Filtration System Reliability

Clean, contaminant-free fuel and hydraulic fluid are essential to stable performance. The improved filtration systems reduce the risk of mechanical trouble and enhance longevity and durability.

Hydraulic fluid filter NEW

Recognized as the best in the industry, our super-fine filter separates out even the smallest particles. New cover prevents contamination when changing filters.



Hydraulic fluid filter clog detector NEW

Pressure sensors at the inlet and outlet of the hydraulic fluid filter monitor differences in pressure to determine the degree of clogging. If the difference in pressure exceeds a predetermined level, a warning appears on the multi-display, so any contamination can be removed from the filter before it reaches the hydraulic fluid reservoir.

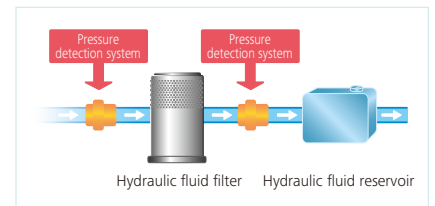

Enlarged fuel filter NEW

The enlarged fuel filter with built-in water separator maximizes filtering performance.

60%
enlarged

Easy cleaning saves time



Detachable two-piece floor mat has handles for easy removal. The mat's raised edges trap dirt and grit for easy cleaning.

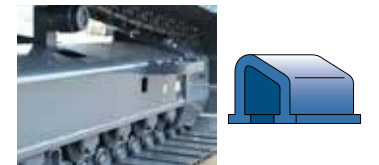

Special crawler frame design makes it easy to clean off mud.



Double-element air cleaner

The large-capacity element features a double-filter structure that keeps the engine protected under the most demanding job conditions and backed up with an audible filter clog alarm in the operator's cab.

Long-life hydraulic oil:
5,000
hours

Long-interval maintenance

Long-life hydraulic oil reduces cost and labor.

Replacement cycle:
1,000
hours

Highly durable super-fine filter

The high-capacity hydraulic oil filter incorporates glass fiber with superior cleaning power and durability.



Remote monitoring for peace of mind

KOMEXS (Kobelco Monitoring Excavator System) uses satellite communication and internet to relay data, and therefore can be deployed in areas where other forms of communication are difficult.

When a hydraulic excavator is fitted with this system, data on the machine's operation, such as operating hours, location, fuel consumption, and maintenance status can be obtained remotely.

Direct Access to Operational Status

Location data

• Accurate location data can be obtained even from sites where communications are difficult.

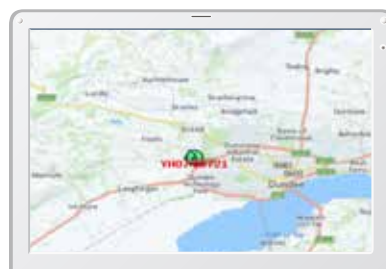

Latest location



Location records



Work data

Operating hours

- A comparison of operating times of machines at multiple locations shows which locations are busier and more profitable.
- Operating hours on site can be accurately recorded, for running time calculations needed for rental machines, etc.

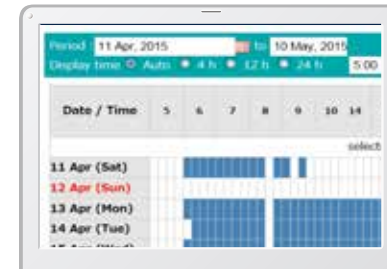

Daily report

Fuel consumption data

- Data on fuel consumption and idling times can be used to indicate improvements in fuel consumption.

Work mode	Working Hrs	Total Fuel Consumption
H mode	2:06	24.5 L
S mode	0:00	0.0 L
E mode	169:19	1489.7 L
TOTAL	171:25	1514.2 L

Fuel consumption

Graph of work content

- The graph shows how working hours are divided among different operating categories, including digging, idling, traveling and optional operations.



Work status

Maintenance Data and Warning Alerts

Machine maintenance data

- Provides maintenance status of separate machines operating at multiple sites.
- Maintenance data is also relayed to KOBELCO service personnel, for more efficient planning of periodic servicing.

Model	Serial No.	Hour Meter	Engine Oil
SK135RCL-3/SK140RCL	YH07-09221	734 Hr	434
SK135RCL-3/SK140RCL	YH07-09289	73 Hr	429
SK210LC-9	YQ11-10454	960 Hr	58
SK210LC-9	YQ11-10481	540 Hr	490
SK75SR-	Y708-30374		

Maintenance

Warning alerts

- This system warns an alert if an anomaly is sensed, preventing damage that could result in machine downtime.

Alarm information can be received through E-mail

- Alarm information or maintenance notice can be received through E-mail, using a computer or cell phone.



Daily/Monthly reports

- Operational data downloaded onto a computer helps in formulating daily and monthly reports.

Security system

Engine start alarm

- The system can transmit and alarm, if the machine is operated outside designated time.

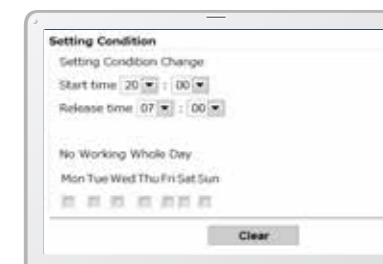

Engine start alarm outside prescribed work time

Area alarm

- The system can transmit and alarm, if the machine is moved out of its designated area to another location.



Alarm for outside of reset area

Engine

Model	HINO J05EUM-KSSL	
Type	Water-cooled, 4 cycle 4 cylinder direct injection type diesel engine with intercooler turbo-charger.	
No. of cylinders	4	
Bore and stroke	4.41" {112 mm} x 5.12" {130 mm}	
Displacement	312.6 cu.in {5.123 L}	
Rated power output	(SAE NET)	160 hp {119 kW} /2,000 min ⁻¹
	(Without fan)	166 hp {124 kW} /2,000 min ⁻¹
Max. torque	(SAE NET)	472 lb-ft {640 N·m} /1,600 min ⁻¹
	(Without fan)	487 lb-ft {660 N·m} /1,600 min ⁻¹

Hydraulic System

Pump	
Type	Two variable displacement piston pumps
Max. discharge flow	2 x 58.1 U.S.gph {2 x 220 L/min} 1 x 5.3 U.S.gph {1 x 20 L/min}
Relief valve setting	
Boom, arm and bucket	4,970 psi {34.3 Mpa}
Power boost	5,480 psi {37.8 Mpa}
Travel circuit	4,970 psi {34.3 Mpa}
Swing circuit	4,210 psi {29.0 Mpa}
Control circuit	725 psi {5.0 Mpa}
Pilot control pump	Gear type
Main control valves	8-spool
Oil cooler	Air cooled type

Hydraulic P.T.O

Specification	Output	Maximum Pressure PSI (Mpa)	Max Flow US GPM, (lpm)	
			2,000rpm	1,000rpm
N&B		4,970 (34.3)	116.2 (440)	7.9 (30)
			2,990 (20.6)	10.8 (41)
Rotary				

Swing System

Swing motor	Axial piston motor
Parking brake	Oil disk brake, hydraulic operated automatically
Swing speed	12.6 rpm {12.6 min ⁻¹ }
Swing torque	52,700 lb-ft {71.4 kN·m} (SAE)
Tail swing radius	6'0" {1,840 mm}
Min. front swing radius	7'8" {2,370 mm}

Bucket Selection Chart

Bucket type	Capacity (SAE) Cubic Yard (m ³)	Width Inches (m)	Bucket Weight lb (kg)	Arm ft-in (m)	
				9'5" (2.87)	
General	.91 (.695)	30" (.762)	1,325 (601)	H	
	1.14 (.871)	36" (.914)	1,450 (658)	H	
	1.37 (1.047)	42" (1.066)	1,651 (749)	M	
	1.6 (1.223)	48" (1.219)	1,780 (807)	L	
Heavy Duty	.68 (.519)	24" (.609)	1,250 (567)	H	
	.91 (.695)	30" (.762)	1,420 (644)	H	
	1.14 (.871)	36" (.914)	1,560 (708)	M	
	1.37 (1.04)	42" (1.066)	1,730 (785)	L	
Severe Duty	1.6 (1.233)	48" (1.219)	1,905 (864)	X	
	.63 (.481)	26" (.66)	1,455 (660)	H	
	.75 (.573)	31" (.787)	1,590 (721)	H	
	.88 (.672)	37" (.939)	1,790 (812)	M	
	1.13 (.871)	43" (1.092)	2,000 (907)	L	

H - Used with material weight up to 3,000 lbs/cu yd (1,780 kg/m³) M - Used with material weight up to 2,500 lbs/cu yd (1,483 kg/m³)
L - Used with material weight up to 2,000 lbs/cu yd (1,186 kg/m³) X - Not recommended

Travel System

Travel motor	2 x axial piston type
Parking brakes	Oil disc brake per motors
Travel shoes	49 each side
Travel speed (high/low)	3.6 / 2.2 mph {5.8 / 3.5 km/h}
Drawbar pulling force	51,500 lbs {229.0 kN}(SAE J 1309)
Gradeability	70 % {35 deg}
Ground clearance	1'5" {455 mm}

Cab & Control

Cab	
All-weather, sound-suppressed steel cab mounted on the silicon-sealed viscous mounts and equipped with a heavy, insulated floor mat.	
Control	
Two hand levers and two foot pedals for travel	
Two hand levers for excavating and swing	
Electric rotary-type engine throttle	

Boom, Arm & Bucket

Boom cylinders	2-4.7" {120 mm} x 4' 5" {1,355 mm}
Arm cylinder	1-5.1" {130 mm} x 4'7" {1,406 mm}
Bucket cylinder	1-4.3" {110 mm} x 3'6" {1,064 mm}

Dozer Blade (Optional)

Dozer cylinder	5.5" {140 mm} x 7.9" {200 mm}
Dimension	10'5" {3,180 mm}(width) x 2'3" {685 mm}(height)
Working range	1'9" {545 mm}(up) x 1'3" {370mm}(down)

Refilling Capacities & Lubrications

Fuel tank	87.2 U.S.gal {330 L}
Cooling system	6.3 U.S.gal {24 L}
Engine oil	5.4 U.S.gal {20.5 L}
Travel reduction gear	2x1.3 U.S.gal {2x5.0 L}
Swing reduction gear	0.7 U.S.gal {2.7 L}
Hydraulic oil tank	30.1 U.S.gal {114 L} tank oil level
	60.8 U.S.gal {230 L} hydraulic system
DEF/AdBlue tank	9.0 U.S.gal {33.9 L}

Working Ranges

Unit: ft-in{mm}

Boom	18'4" {5.62m}	
Range	9'5" {2.87m}	
a- Max. digging reach	31'10" {9,700}	
b- Max. digging reach at ground level	31'3" {9,530}	
c- Max. digging depth	21'7" {6,580}	
d- Max. digging height	34'9" {10,580}	
e- Max. dumping clearance	25'4" {7,710}	
f- Min. dumping clearance	9'9" {2,980}	
g- Max. vertical wall digging depth	19'6" {5,950}	
h- Min. swing radius	7'8" {2,370}	
i- Horizontal digging stroke at ground level	16'6" {5,030}	
j- Digging depth for 8 feet flat bottom	20'11" {6,370}	
Bucket capacity ISO heaped cu.yd. {m ³ }	1.05 {0.80}	

Digging Force

Unit: lbs {kN}

Arm length	9'5" {2.87m}	
Bucket digging force	SAE	24,300 {108}
	ISO	26,800 {119}* 27,000 {120}
Arm crowding force	SAE	19,200 {85.5}
	ISO	21,200 {94.1}* 19,800 {88}
		21,800 {96.8}*

* Power Boost engaged.

Dimensions

Unit: ft-in{mm}

Arm length	9'5" {2.87m}	
A Overall length	28'11" {8,830}	
B Overall height (to top of boom)	10'4" {3,160}	
C Overall width of crawler	10'4" {3,180}	
D Overall height (to top of cab)	10'4" {3,160}	
E Ground clearance of rear end*	3'5" {1,030}	
F Ground clearance*	1'5" {455}	
G Tail swing radius	6'0" {1,840}	

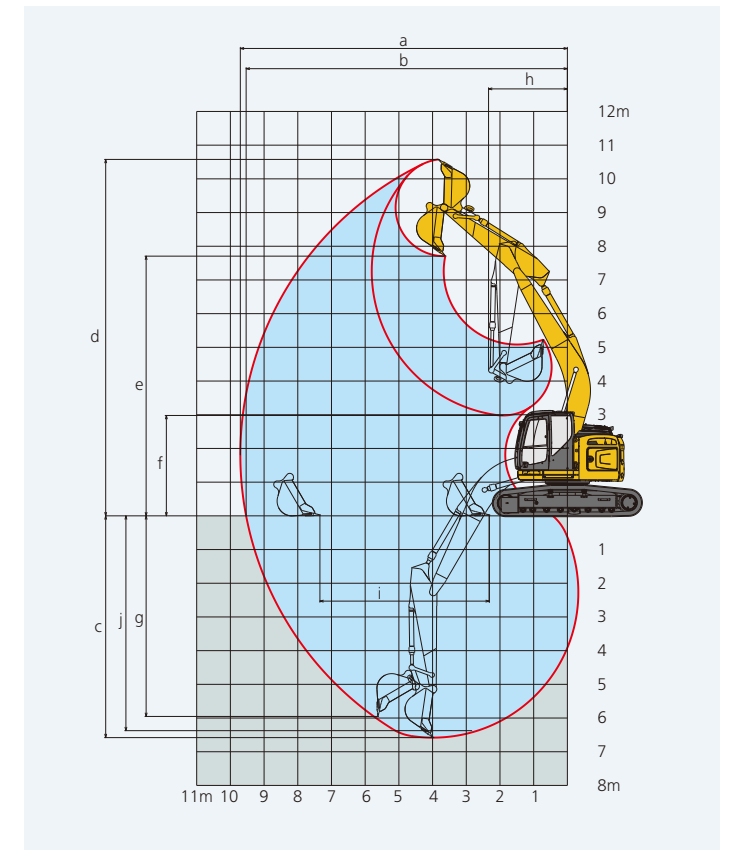

Unit: ft-in{mm}

G' Distance from center of swing to rear end	6'0" {1,840}
H Tumbler distance	12'0" {3,660}
I Overall length of crawler	14'7" {4,450}
J Track gauge	7'1" {2,390}
K Shoe width. In(mm)	2'6" {790}
L Overall width of upperstructure	9'10" {2,990}

* Without including height of shoe lug.

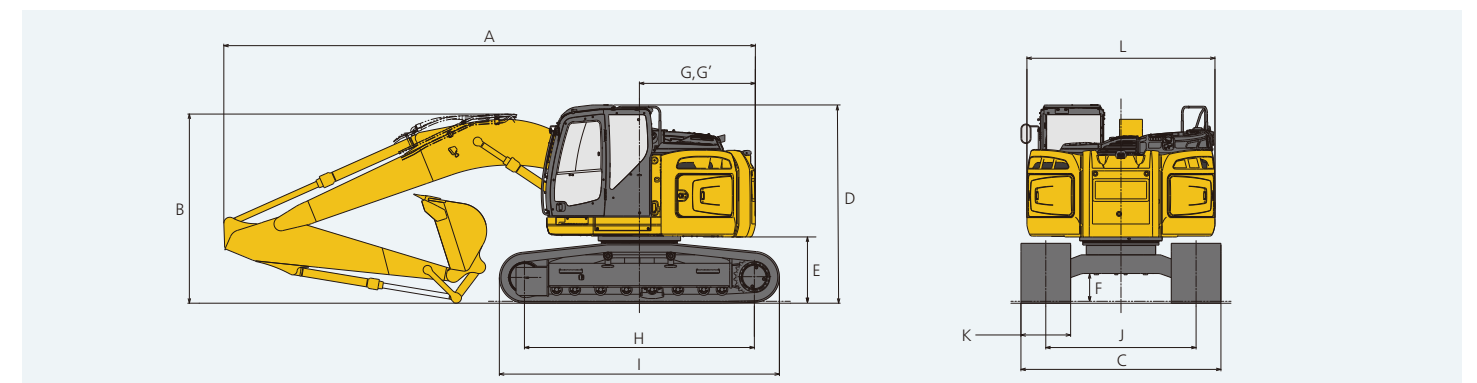

Operating Weight & Ground Pressure

In standard trim, with standard boom, 9'5" {2.87m} arm, and 1.05 cu.yd. {0.8m³} SAE heaped bucket

Shaped		Triple grouser shoes (even height)		Shaped		Triple grouser shoes (even height)	
Shoe width	inches (mm)	31" {790}		Shoe width	inches (mm)	31" {790}	
Ground pressure	psi (kPa)	5.80 {40.0}		Ground pressure with dozer	psi (kPa)	6.22 {42.9}	
Operating weight	lbs (kg)	56,400 {25,600}		Operating weight with dozer	lbs (kg)	60,000 {27,200}	

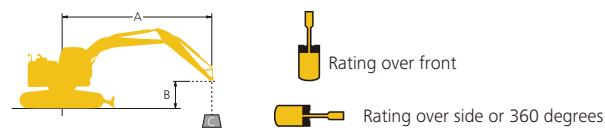

Lifting Capacity

Arm: 9'5" (2.87m) No Bucket, Heavy Counterweight, 31.1" (790mm) shoe (HEAVY LIFT) Dozer: Less		A												Radius		
B		5' (1.5m)		10' (3.0m)		15' (4.6m)		20' (6.1m)		25' (7.6m)		At Max				
30' (9.1m)	lb (kg)													* 9,010 (4,080)	* 9,010 (4,080)	12'2" (3.71m)
25' (7.6m)	lb (kg)					* 11,590 (5,250)	* 11,590 (5,250)							* 7,190 (3,260)	* 7,190 (3,260)	19'2" (5.85m)
20' (6.1m)	lb (kg)					* 12,740 (5,770)	* 12,740 (5,770)	* 11,450 (5,190)	* 11,450 (5,190)					* 6,650 (3,010)	* 6,650 (3,010)	23'2" (7.06m)
15' (4.6m)	lb (kg)			* 19,030 (8,630)	* 19,030 (8,630)	* 16,860 (7,640)	* 16,860 (7,640)	* 14,440 (6,540)	12,110 (5,490)	* 8,280 (3,750)	* 8,280 (3,750)			* 6,540 (2,960)	* 6,540 (2,960)	25'6" (7.79m)
10' (3.0m)	lb (kg)			* 27,980 (12,690)	* 27,980 (12,690)	* 20,480 (9,280)	17,630 (7,990)	* 15,960 (7,230)	11,610 (5,260)	* 12,030 (5,450)	8,380 (3,800)			* 6,730 (3,050)	* 6,730 (3,050)	26'9" (8.17m)
5' (1.5m)	lb (kg)					* 23,460 (10,640)	16,580 (7,520)	* 17,380 (7,880)	11,120 (5,040)	12,670 (5,740)	8,160 (3,700)			* 7,220 (3,270)	* 7,220 (3,270)	27'1" (8.26m)
Ground Level	lb (kg)			* 14,780 (6,700)	* 14,780 (6,700)	* 24,430 (11,080)	16,000 (7,250)	17,240 (7,810)	10,770 (4,880)	12,490 (5,660)	7,990 (3,620)			* 8,130 (3,680)	* 7,420 (3,360)	26'5" (8.05m)
-5' (-1.5m)	lb (kg)	* 14,950 (6,780)	* 14,950 (6,780)	* 24,010 (10,890)	* 24,010 (10,890)	* 23,290 (10,560)	15,840 (7,180)	17,080 (7,740)	10,630 (4,820)					* 9,810 (4,440)	* 8,070 (3,660)	24'8" (7.54m)
-10' (-3.0m)	lb (kg)	* 24,560 (11,140)	* 24,560 (11,140)	* 26,840 (12,170)	* 26,840 (12,170)	* 20,020 (9,080)	15,990 (7,250)	* 14,730 (6,680)	10,750 (4,870)					* 12,760 (5,780)	* 9,650 (4,370)	21'9" (6.63m)
-15' (-4.6m)	lb (kg)			* 17,580 (7,970)	* 17,580 (7,970)	* 13,180 (5,970)	* 13,180 (5,970)							* 11,010 (4,990)	* 11,010 (4,990)	16'10" (5.15m)

SK230SRLC		Arm: 9'5" (2.87m) No Bucket, Heavy Counterweight, 31.1" (790mm) shoe (HEAVY LIFT) Dozer: blade down												Radius		
B		5' (1.5m)		10' (3.0m)		15' (4.6m)		20' (6.1m)		25' (7.6m)		At Max				
30' (9.1m)	lb (kg)													* 9,010 (4,080)	* 9,010 (4,080)	12'2" (3.71m)
25' (7.6m)	lb (kg)					* 11,590 (5,250)	* 11,590 (5,250)							* 7,190 (3,260)	* 7,190 (3,260)	19'2" (5.85m)
20' (6.1m)	lb (kg)					* 12,740 (5,770)	* 12,740 (5,770)	* 11,450 (5,190)	* 11,450 (5,190)					* 6,650 (3,010)	* 6,650 (3,010)	23'2" (7.06m)
15' (4.6m)	lb (kg)			* 19,030 (8,630)	* 19,030 (8,630)	* 16,860 (7,640)	* 16,860 (7,640)	* 14,440 (6,540)	12,750 (5,780)	* 8,280 (3,750)	* 8,280 (3,750)			* 6,540 (2,960)	* 6,540 (2,960)	25'6" (7.79m)
10' (3.0m)	lb (kg)			* 27,980 (12,690)	* 27,980 (12,690)	* 20,480 (9,280)	18,580 (8,420)	* 15,960 (7,230)	12,260 (5,560)	* 12,030 (5,450)	8,870 (4,020)			* 6,730 (3,050)	* 6,730 (3,050)	26'9" (8.17m)
5' (1.5m)	lb (kg)					* 23,460 (10,640)	17,530 (7,950)	* 17,380 (7,880)	11,770 (5,330)	* 14,120 (6,400)	8,650 (3,920)			* 7,220 (3,270)	* 7,220 (3,270)	27'1" (8.26m)
Ground Level	lb (kg)			* 14,780 (6,700)	* 14,780 (6,700)	* 24,430 (11,080)	16,940 (7,680)	* 18,010 (8,160)	11,420 (5,180)	* 14,150 (6,410)	8,480 (3,840)			* 8,130 (3,680)	* 7,880 (3,570)	26'5" (8.05m)
-5' (-1.5m)	lb (kg)	* 14,950 (6,780)	* 14,950 (6,780)	* 24,010 (10,890)	* 24,010 (10,890)	* 23,290 (10,560)	16,790 (7,610)	* 17,380 (7,880)	11,280 (5,110)					* 9,810 (4,440)	* 8,570 (3,880)	24'8" (7.54m)
-10' (-3.0m)	lb (kg)	* 24,560 (11,140)	* 24,560 (11,140)	* 26,840 (12,170)	* 26,840 (12,170)	* 20,020 (9,080)	16,940 (7,680)	* 14,730 (6,680)	11,390 (5,160)					* 12,760 (5,780)	10,230 (4,640)	21'9" (6.63m)
-15' (-4.6m)	lb (kg)			* 17,580 (7,970)	* 17,580 (7,970)	* 13,180 (5,970)	* 13,180 (5,970)							* 11,010 (4,990)	* 11,010 (4,990)	16'10" (5.15m)

- Notes:**
- Do not attempt to lift or hold any load that is greater than these lift capacities at their specified lift point radius and heights. Weight of all accessories must be deducted from the above lift capacities.
 - Lift capacities are based on machine standing on level, firm, and uniform ground. User must make allowance for job conditions such as soft or uneven ground, out of level conditions, side loads, sudden stopping of loads, hazardous conditions, experience of personnel, etc.
 - Bucket pin defined as lift point.

- The above lifting capacities are in compliance with ISO 10567. They do not exceed 87% of hydraulic lifting capacity or 75% of tipping load. Lifting capacities marked with an asterisk (*) are limited by hydraulic capacity rather than tipping load.
- Operator should be fully acquainted with the Operator's and Maintenance Instructions before operating this machine. Rules for safe operation of equipment should be adhered to at all times.
- Lift capacities apply to only machine as originally manufactured and normally equipped by KOBELCO CONSTRUCTION MACHINERY CO., LTD.

2-way Blade Working Ranges and Overall Length

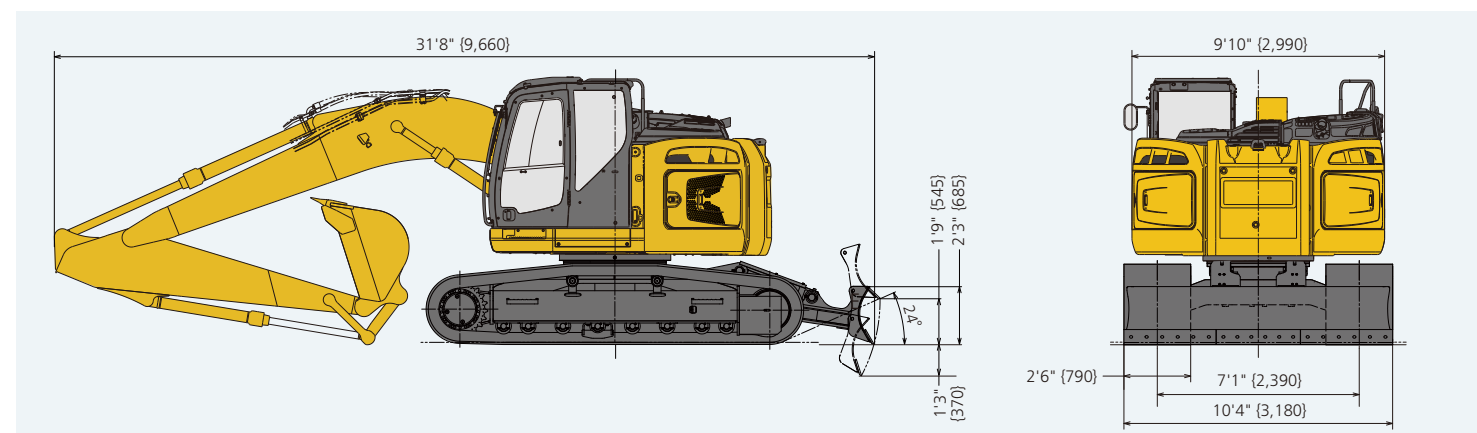

STANDARD EQUIPMENT

ENGINE

- Engine, HINO J05EUM-KSSL, Diesel engine with turbocharger and intercooler, Tier 4 certified
- Automatic engine deceleration
- Batteries (2 x12V - 96 Ah)
- Starting motor (24 V - 5kW), 60 amp alternator
- Engine oil pan drain cock
- Double element air cleaner

CONTROL

- Working mode selector (H-mode, S-mode and ECO-mode)

SWING SYSTEM & TRAVEL SYSTEM

- Swing rebound prevention system
- Straight propel system
- Two-speed travel with automatic shift down
- Sealed & lubricated track links
- Grease-type track adjusters
- Automatic swing brake

MIRRORS & LIGHTS

- Four rear view mirrors and rearview camera
- Three front working lights
- Swing flashers

CAB & CONTROL

- Two control levers, pilot-operated
- Horn, electric
- Integrated left-right slide-type control box
- Cab light (interior)
- Coat hook
- Large cup holder
- Detachable two-piece floor mat
- 7-way adjustable suspension seat
- Retractable seatbelt
- Headrest
- Heater and defroster
- Intermittent windshield wiper with double-spray washer
- Sky light
- Top guard Level II (ISO 10262 : 1998)
- Tinted safety glass
- Pull-type front window and removable lower front window
- Easy-to-read multi-display monitor
- Automatic air conditioner
- Emergency escape hammer
- Bluetooth installed radio (AM/FM Stereo with speakers)
- Travel alarm
- 12V converter
- Control pattern changer (2-way)
- Handrails

OPTIONAL EQUIPMENT

- Front-guard protective structures (may interfere with bucket rotation)
- N&B hydraulic circuit
- Rotate hydraulic circuit
- Additional two work lights on cab
- Vandal Guards available via KOBECO Parts department

- Rain visor (may interfere with bucket action)
- Right view camera
- Air suspension seat with heat
- Boom / arm load lock valves
- Dozer blade

Note: Standard and optional equipment may vary. Consult your KOBELCO dealer for specifics.