

KOMATSU®

PC1250LC-8, PC1250-8 BACKHOE With Tier 3 Engine

NET HORSEPOWER
502 kW 672 HP @ 1800 rpm

OPERATING WEIGHT
Backhoe: 106500–115249 kg
234,790–254,000 lb

BUCKET CAPACITY (SAE)
Backhoe: 3.4 - 6.7 m³
4.4 - 8.8 yd³

PC
1250
LC



Photo may include optional equipment

HYDRAULIC EXCAVATOR

WALK-AROUND

Productivity Features

- **Heavy Lift Mode**
Heavy lift mode increases lifting force by 10%.
- **Large Digging Force**
High operation efficiency with large digging force for severe applications.
- **Two-mode Setting for Boom**
Switch selection allows either powerful digging or smooth boom operation.
- **Twin Swing Motor System** provides excellent swing performance, even on slopes.
- **Large Drawbar Pull and Steering Force** provide excellent mobility.
- **Swing Priority Mode**
Swing priority mode improves efficiency for loading dump trucks at 90° or 180° swing angles.
- **Shockless Boom**
Switch selection reduces chassis vibration after sudden stops.

Excellent Reliability and Durability

- **Booms and arms** are constructed of thick one-piece plates and large castings for extended service life
- **Fuel Pre-filters** with water separator equipped as standard
- **O-ring Face Seals**, which have excellent sealing performance, are used for the hydraulic hoses
- **High-pressure In-line Filtration**
The cool-running hydraulic system is protected with the most extensive filtration system available, including a high pressure in-line filter for each main pump.



Easy Maintenance

- **Easy Cleaning of Cooling Unit**
Fan reverse-rotation function helps keep radiator and oil cooler clean.
- **Centralized Arrangement of Engine Checkpoints**
- **Slip-resistant Plates** for improved foot traction
- **Large Handrails, Steps and Catwalk** provide easy access to the engine, hydraulic equipment, and cab
- **Highly Reliable Electronic Devices**
Exclusively designed electronic devices have passed severe testing.
 - Controllers
 - Sensors
 - Connectors
 - Heat resistant wiring
 - Circuit breaker
- **Boom Foot Hoses** are arranged under the boom foot to reduce hose bend during operation and extend hose life.

Ecology and Economy Features

- **Komatsu SAA6D170E-5 Engine is EPA Tier 3 Emissions Certified**
 - World's first cooled EGR system with bypass-assist type electronically controlled venturi
 - Offers high power and low fuel consumption, while conforming to EPA Tier 3 emission regulations
 - Reduces NOx emissions by approximately 40%
 - Equipped with an electronically controlled variable speed reversible fan
- **Economy Mode Four-level Setting**
Enables operator to select the appropriate Economy mode level to match production requirement with lowest fuel consumption.
- **Reduction of Ambient Noise**
 - Electronically controlled variable speed fan drive
 - Large hybrid fan
 - Glasswool type low-noise muffler with noise reducing cover

NET HORSEPOWER
502 kW 672 HP @ 1800 rpm

OPERATING WEIGHT
Backhoe
106500–115249 kg
234,790–254,000 lb

BUCKET CAPACITY (SAE)
Backhoe
3.4 - 6.7 m³ 4.4 - 8.8 yd³



Photo may include optional equipment.

Working Environment

- **Large Comfortable Cab**
 - Low noise and vibration with cab damper mounting
 - Large-capacity automatic air conditioner
 - Pressurized cab reduces external dust from entering
 - OPG top guard level 2 is standard (ISO 10262)



Advanced Monitor Features

- Machine condition can be checked with Equipment Management Monitoring System (EMMS)
- EMMS provides PM scheduling, error code, and failure diagnostic functions
- Two working modes combine with heavy lift mode for maximum productivity

PRODUCTIVITY FEATURES



Komatsu's "ecot3" engines are designed to deliver optimum performance under the toughest of conditions, while meeting the latest environmental regulations. This engine is EPA Tier 3, EU Stage 3A and Japan emissions certified. "ecot3" – ecology and economy combined with Komatsu technology to create a high performance engine without sacrificing power or productivity.

Environment-Friendly Clean Engine

The PC1250LC-8, which is equipped with the Komatsu SAA6D170E-5 engine, is USA EPA Tier 3 and EU stage 3A emission certified. The SAA6D170E-5 engine adopts the world's first cooled EGR system with electronically controlled bypass-assist type venturi. NOx emissions are reduced by 40%, while maintaining high power and low fuel consumption.

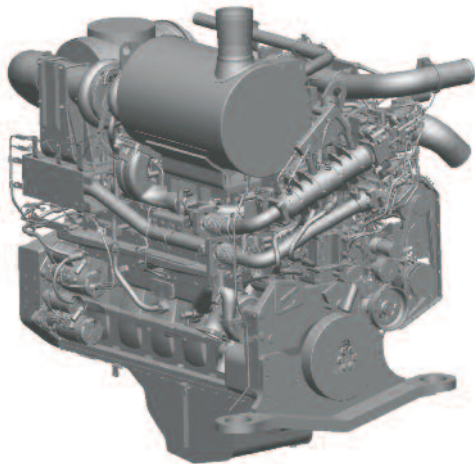
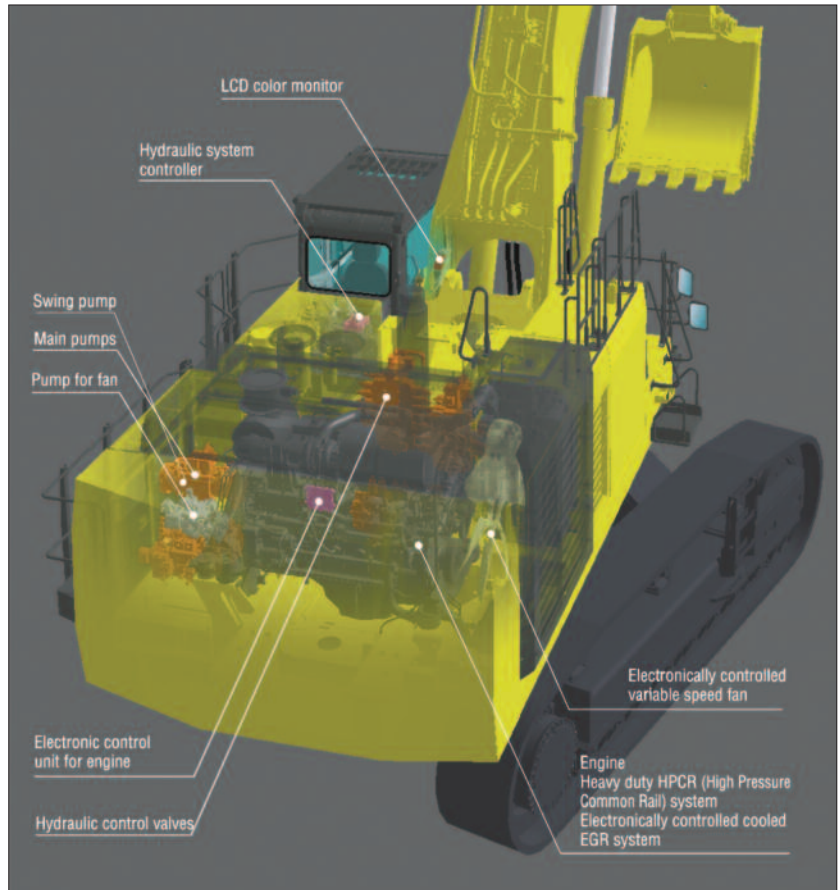

The above image is a 3D illustration and may differ from actual engine.

Fuel Consumption Reduced Using Economy Mode

Enables operator to set Economy mode to any of four levels according to working conditions. Production requirement is achieved at lowest possible fuel consumption.

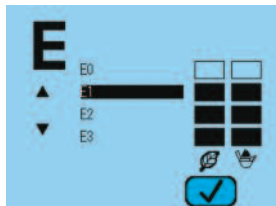

Electronically Controlled Variable Speed Fan Contributes to Low Fuel Consumption and Low Noise

The electronic control system sets the rotational speed of the cooling fan according to coolant, hydraulic oil, and ambient temperatures. It effectively uses engine output to reduce wasteful fuel consumption and reduces noise during low-speed fan rotation.



Reduction of Ambient Noise

In addition to the electronically-controlled variable-speed fan drive, noise levels are further reduced with a low-noise muffler with cover, hybrid fan, low-noise components, and sound absorbing padding installed throughout the machine.

Large Digging Force

With its high engine output and efficient hydraulic system, the PC1250LC-8 demonstrates powerful digging force.

Max. arm crowd force (SAE): 392 kN 44.1 US ton

Max. bucket digging force (SAE): 422 kN 47.4 US ton

Large Drawbar Pull and Steering Force

Since the machine has large drawbar pull and high steering force, it demonstrates excellent mobility even when operated on inclined sites.

Two-Mode Setting for Boom

Smooth mode provides easy operation for gathering blasted rock and scraping operations. When maximum digging force is needed, switch to **Power mode** for more effective excavating.

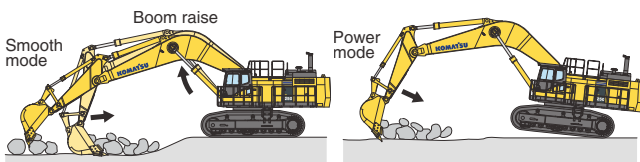

Shockless Boom Control

The PC1250LC-8 features a shockless boom control (double-check slow return valve) which automatically reduces the amount of vibration present when operating the boom. Operator fatigue is reduced and spillage caused by vibration is minimized.

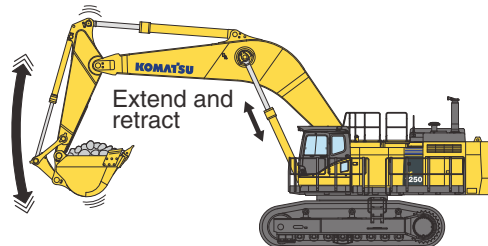

Working Mode Selection

Power and Economy Mode

The PC1250LC-8 excavator is equipped with two working modes. Each mode is designed to match engine speed, pump flow, and system pressure to the current application, giving the operator flexibility to match equipment performance to the job at hand.

Working Mode	Application	Advantage
P	Power Mode	<ul style="list-style-type: none"> • Maximum production/power • Fast cycle time
E (E0,E1,E2,E3)	Economy Mode	<ul style="list-style-type: none"> • Good cycle time • Improved fuel economy

Heavy Lift Mode

Gives the operator 10% more lifting force on the boom when needed for handling large rock or heavy lifting applications.

Swing Priority Setting

The swing priority setting allows the operator to use the same easy motion for 180° loading as 90° loading operations. By proportioning the oil flow, this setting allows the operator to select either boom or swing as the priority for increased production.



RELIABILITY FEATURES

Excellent Reliability and Durability

Boom Foot Hoses

The boom foot hoses are arranged under the boom foot to reduce hose bend during operation and extending hose life.



Strengthened Boom and Arm

With large cross-sectional structures, thick high tensile strength steel plates, and partition walls, the boom and arm structures exhibit excellent durability and are highly resistant to bending and torsional stress.

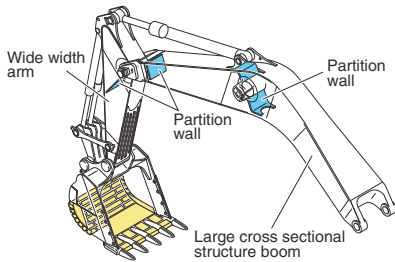

O-Ring Face Seal

Hydraulic hose seals have been changed from a conventional taper seal to an O-ring seal. This provides improved long-term sealing performance.

Fuel Pre-Filters (with Water Separator)

Removes water and contaminants from fuel to enhance fuel system reliability.



High-Pressure In-line Filtration

The PC1250LC-8 has the most extensive filtration system available, providing in-line filters as standard equipment. An in-line high pressure filter in the outlet port of each main hydraulic pump reduces failures caused by contamination.

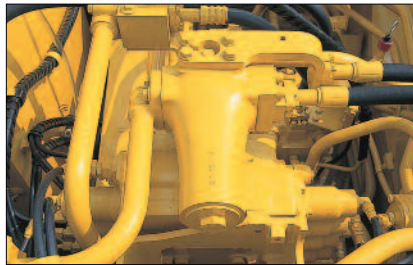

Metal Guard Rings

Metal guard rings protect all the hydraulic cylinders and improve reliability.

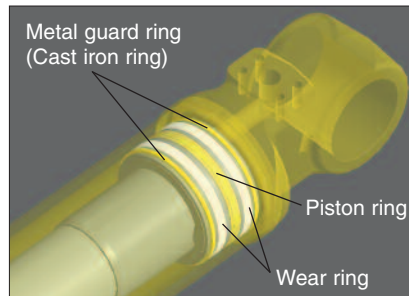

Heat-Resistant Wiring

Heat-resistant wiring is utilized for the engine electrical circuits and other major component circuits.

Circuit Breaker

With the standard circuit breaker, the machine can be easily restarted after repair.



Sturdy Undercarriage

The undercarriage is strengthened to provide excellent reliability and durability when working on rocky ground or blasted rock.



Sturdy guards shield the travel motors and piping from rock damage.



Track roller guard (full length)
(PC1250-8 option)

Tough Strengthened Frame Structure

Strengthened revolving frame, center frame and crawler frames withstand severe applications with excellent durability.

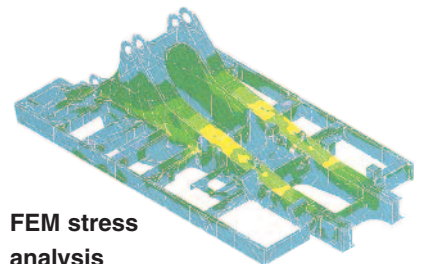

FEM stress analysis

DT-Type Connectors

DT-type connectors seal tight and have high reliability.

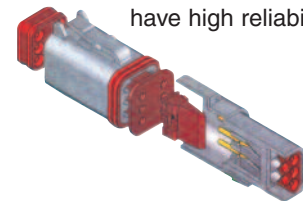

WORKING ENVIRONMENT

The cab interior is spacious and provides a comfortable working environment...

Large Comfortable Cab

Comfortable Cab

The PC1250LC-8's cab offers an exceptionally comfortable operating environment. The large cab enables full flat reclining of the seat back with headrest.

Pressurized Cab

The automatic air conditioner, air filters and a higher internal air pressure (6.0 mm Aq **0.2" Aq**) reduces external dust from entering the cab.

Low Noise Design

Both engine noise and swing and hydraulic relief noise are remarkably reduced.

Low Vibration with Cab Damper Mounting

The PC1250LC-8 uses a new, improved cab damper mount system that incorporates longer stroke and the addition of a spring. The new cab damper mounting, combined with a strengthened left and right side deck, aids vibration reduction at the operator's seat.

Vibration at the floor is reduced from 120 dB (VL) to 115 dB (VL).

dB (VL) is an index for expressing size of vibration.

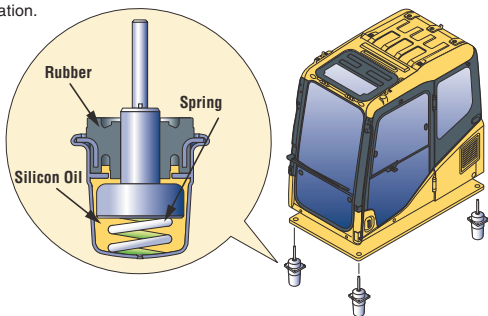

Comparison of Riding Comfort

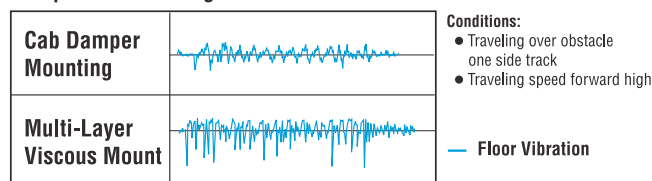

Vertical direction on graph shows size of vibration.



Photo may include optional equipment

Automatic Air Conditioner

A 6900 kcal **27,400 Btu** automatic air conditioner is standard. The bi-level control function keeps the operator's head and feet cool and warm respectively. This improved air flow function keeps the inside of the cab comfortable throughout the year.

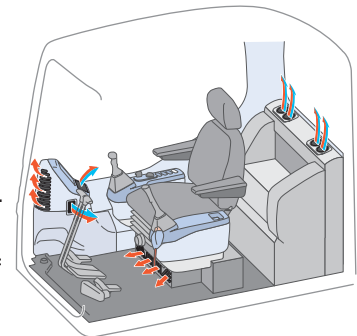

Washable Cab Floormat

The PC1250LC-8's cab floormat is easy to keep clean. The gently inclined surface has a flanged floormat and drainage holes to facilitate runoff.



Sliding Window On Left Side of Cab



PC1250LC-8 HYDRAULIC EXCAVATOR



Seat with headrest reclined full flat

Photo may include optional equipment

Multi-Position Control

The multi-position, Proportional Pressure Control (PPC) levers allow the operator to work in comfort while maintaining precise control. A double-slide mechanism allows the seat and control levers to move together or independently, allowing the operator to position the controls for maximum productivity and comfort.



Seat Sliding Amount: 340 mm 13.4"



Defroster



Cab Frame Mounted Wiper



Bottle Holder and Magazine Rack

General Features

Step light with timer

provides light for about one minute to allow the operator to exit the machine after operation.



Pump/engine room partition

Separates the engine room from the hydraulic compartment.

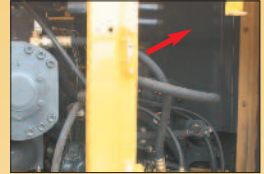

Thermal and fan guards are placed around high-temperature parts of the engine and fan drive.

Slip-resistant plates

Serrated plates on working surfaces provide improved foot traction.



Slip-resistant plates

Horn interconnected with warning light gives visual and audible notice for directing trucks or other communication.

EASY MAINTENANCE

Komatsu Designed the PC1250LC-8 for Easy Service Access

Easy Checking and Maintenance

Wide center walkway provides easy access to most inspection and maintenance points. In addition, inspection and maintenance points are grouped to facilitate easy engine and hydraulic component checks.

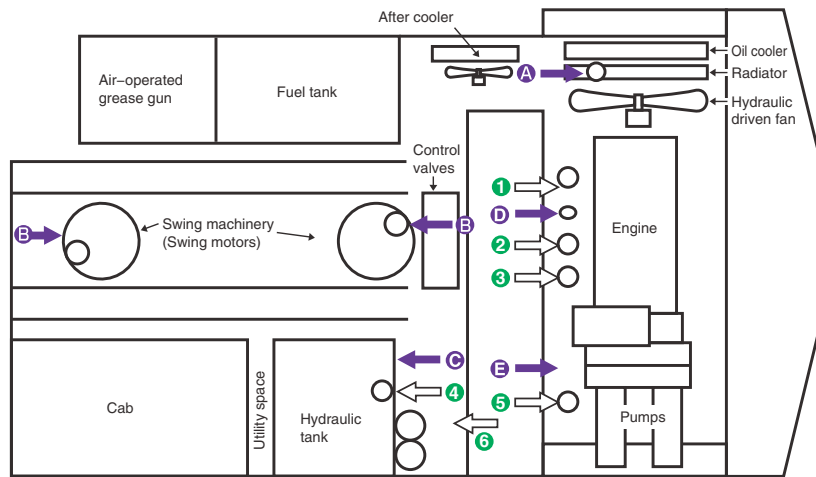

- A** Coolant
- B** Swing transmission oil
- C** Hydraulic oil
- D** Engine oil
- E** PTO oil
- 1** Corrosion resister
- 2** Fuel filters
- 3** Engine oil filters
- 4** Hydraulic drain filter
- 5** Pilot filter
- 6** Hydraulic return filters

Wide Catwalk, Large Steps and Handrails

Easier, safer operator cab access and maintenance checks.



Easy Cleaning of Radiator

The hydraulically driven fan can be reversed from the cab to facilitate cleaning of the cooling unit. In addition, this feature can be used to reduce warm-up time in low temperatures.



Reduced Maintenance Costs

Hydraulic oil filter replacement is extended from 500 to 1000 hours.



Dust Indicator with 5-step Indication

Informs of air cleaner clogging in 5 steps to warn of filter condition.



Convenient Utility Space

Utility space provides great convenience to store tools, coveralls, filters, etc.



Electric priming pump

Bleeding air from fuel system is easily accomplished with the electric priming pump.



Electric priming pump switch



PC1250LC-8 HYDRAULIC EXCAVATOR

High-Quality EMMS Self-diagnostic System

• Abnormality Checking Function

If an abnormality should occur, the monitoring system checks whether hydraulic pressures, solenoid ON/OFF status, engine speed, electrical connections, etc. are within normal operating range.

• Maintenance History Memory Function

Maintenance records such as replacement of engine oil, hydraulic oil, filters, can be stored. Operator is warned when service is due.

• Trouble Data Memory Function

Trouble data is stored to serve as reference for future trouble-shooting. Error codes are displayed to aid in service diagnosis.

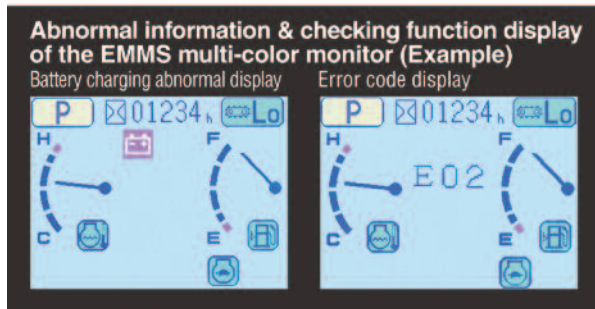
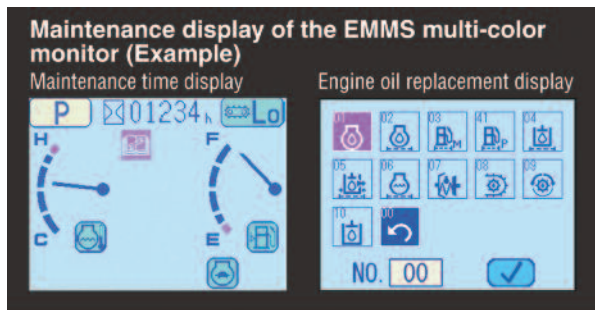

KOMTRAX Plus

As part of a complete service and support program, Komatsu equips every mining and quarry sized machine with KOMTRAX Plus. By using a satellite-based communication system, KOMTRAX Plus offers a new vision of monitoring your valuable assets by providing insight to critical operating metrics and information that can be used to increase availability, lower owning and operating costs and maximize fuel efficiency.

The KOMTRAX Plus information available on MyKomatsu.com allows service personnel and asset owners to review cautions, operational data, fuel consumption, payloads and key component measurements provided in forms of trends. With KOMTRAX Plus, knowledge becomes the power to fuel your productivity.



Photo may include optional equipment.

SPECIFICATIONS



ENGINE

Model Komatsu SAA6D170E-5
 Type 4-cycle, water-cooled, direct injection
 Aspiration Turbocharged, aftercooled, cooled EGR
 Number of cylinders 6
 Bore 170 mm **6.69"**
 Stroke 170 mm **6.69"**
 Piston displacement 23.15 ltr **1413 in³**
 Governor All-speed, electronic
 Horsepower
 SAE J1995 Gross 514 kW **688 HP**
 ISO 9249 / SAE J1349 Net 502 kW **672 HP**
 Hydraulic fan at maximum speed Net 463 kW **620 HP**
 Rated rpm 1800 rpm
 Fan drive type Hydraulic, variable speed, reversible
 EPA Tier 3 and EU stage 3A emission certified.



HYDRAULIC SYSTEM

Type Open-center load sensing system
 Number of selectable working modes 2
 Main pumps:
 Type Variable capacity piston pumps
 Pumps for Boom, arm, bucket, swing, and travel circuits
 Maximum flow:
 For implement and travel 2 x 494 ltr/min **2 x 130.5 U.S. gpm**
 For swing 1 x 600 ltr/min **1 x 158.5 U.S. gpm**
 Sub-pump for control circuit Gear pump
 Hydraulic motors:
 Travel 2 x axial piston motors with parking brake
 Swing 2 x axial piston motors with swing holding brake
 Relief valve setting:
 Implement circuits 31.4 MPa 320 kg/cm² **4,550 psi**
 Travel circuit 34.3 MPa 350 kg/cm² **4,980 psi**
 Swing circuit 27.0 MPa 275 kg/cm² **3,910 psi**
 Pilot circuit 2.9 MPa 30 kg/cm² **430 psi**
 Hydraulic cylinders:
 Number of cylinders—bore x stroke
 Backhoe
 Boom 2 – 225 mm x 2390 mm **8.9" x 94.1"**
 Arm 1 – 250 mm x 2435 mm **9.8" x 95.9"**
 Bucket
 Std 2 – 160 mm x 1825 mm **6.3" x 71.8"**
 SP 2 – 160 mm x 1950 mm **6.3" x 76.8"**



SWING SYSTEM

Driven by 2 x hydraulic motors
 Swing reduction Planetary gear
 Swing circle lubrication Grease bathed
 Swing lock Oil disc brake
 Swing speed 5.5 rpm



DRIVES AND BRAKES

Steering control Two levers with pedals
 Drive method Fully hydrostatic
 Travel motor Axial piston motor, in-shoe design
 Reduction system Planetary double reduction
 Maximum drawbar pull 686 kN 70000 kg **154,320 lb**
 Gradeability 70%
 Maximum travel speed: High 3.2 km/h **2.0 mph**
 Low 2.1 km/h **1.3 mph**
 Service brake Hydraulic lock



UNDERCARRIAGE

Center frame H-leg frame
 Track frame Box-section
 Track type Sealed
 Track adjuster Hydraulic
 No. of shoes
 Standard, SP 48 each side
 LC 55 each side
 No. of carrier rollers 3 each side
 No. of track rollers
 Standard, SP 8 each side
 LC 10 each side



COOLANT AND LUBRICANT CAPACITY (REFILLING)

Fuel tank 1360 ltr **359.3 US gal**
 Radiator 142 ltr **37.5 US gal**
 Engine 86 ltr **22.7 US gal**
 Final drive, each side 21 ltr **5.5 US gal**
 Swing drive 2 x 24.3 ltr **2 x 6.4 US gal**
 Hydraulic tank 670 ltr **177.0 US gal**
 PTO 13.5 ltr **3.6 US gal**



OPERATING WEIGHT (APPROXIMATE)

BACKHOE
 PC1250-8: 9100 mm **29'10"** boom, 3400 mm **11'2"** arm, SAE heaped 5.0 m³ **6.5 yd³** backhoe bucket, operator, lubricant, coolant, full fuel tank, and standard equipment.
 PC1250LC-8: 9100 mm **29'10"** boom, 3400 mm **11'2"** arm, SAE heaped 5.0 m³ **6.5 yd³** backhoe bucket, operator, lubricant, coolant, full fuel tank, and standard equipment.

Shoes	PC1250-8		PC1250LC-8	
	Operating Weight	Ground Pressure	Operating Weight	Ground Pressure
Double grouser 700 mm 28"	106500 kg 234,790 lb	1.39 kgf/cm ² 19.8 psi	—	—
Double grouser 1000 mm 39.4"	108810 kg 239,880 lb	0.99 kgf/cm ² 14.1 psi	113500 kg 250,154 lb	0.88 kgf/cm ² 12.5 psi
Double grouser 1200 mm 47.25"	—	—	115249 kg 254,000 lb	0.75 kgf/cm ² 10.7 psi

WORKING RANGE



WORKING RANGE

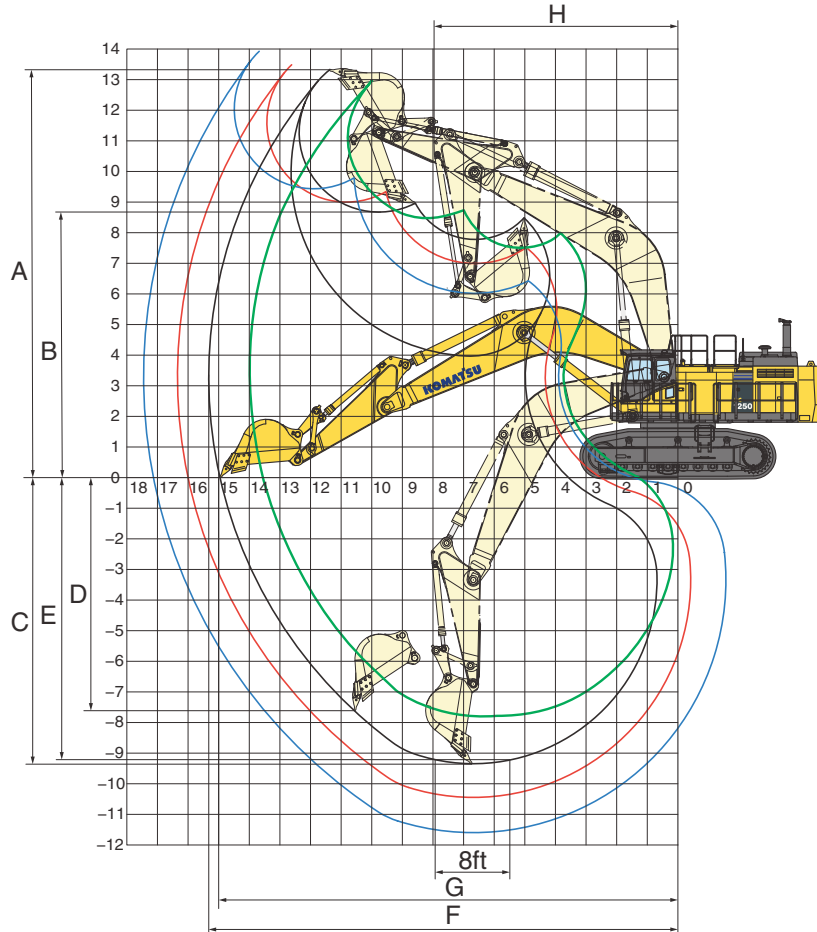

	PC1250-8/PC1250LC-8			PC1250SP-8
	9.1 m 29'10" boom			7.8 m 25'7" boom
	3.4 m 11'2" arm	4.5 m 14'9" arm	5.7 m 18'8" arm	3.4 m 11'2" arm
A Max. digging height	13400 mm 44'0"	13490 mm 44'3"	13910 mm 45'8"	13000 mm 42'8"
B Max. dumping height	8680 mm 28'6"	9000 mm 29'6"	9440 mm 31'0"	8450 mm 27'9"
C Max. digging depth	9350 mm 30'8"	10440 mm 34'3"	11590 mm 38'0"	7900 mm 25'11"
D Max. vertical wall digging depth	7610 mm 25'0"	8490 mm 27'10"	9480 mm 31'1"	5025 mm 16'6"
E Max. digging depth of cut for 8' level	9220 mm 30'3"	10340 mm 33'11"	11500 mm 37'9"	7745 mm 25'5"
F Max. digging reach	15350 mm 50'4"	16340 mm 53'7"	17450 mm 57'3"	14070 mm 46'2"
G Max. digging reach at ground level	15000 mm 49'3"	16000 mm 52'6"	17130 mm 56'2"	13670 mm 44'10"
H Min. swing radius	7965 mm 26'2"	7990 mm 26'3"	8150 mm 26'9"	6415 mm 21'1"
Bucket digging force (SAE)	422 kN 43000 kgf / 94,800 lb	422 kN 43000 kgf / 94,800 lb	343 kN 35000 kgf / 77,160 lb	502 kN 51200 kgf / 112,900 lb
Arm crowd force (SAE)	392 kN 40000 kgf / 88,180 lb	327 kN 33300 kgf / 73,410 lb	281 kN 28700 kgf / 63,270 lb	395 kN 40300 kgf / 88,860 lb
Bucket digging force (ISO)	479 kN 48800 kgf / 107,590 lb	479 kN 48800 kgf / 107,590 lb	389 kN 39700 kgf / 87,520 lb	570 kN 58100 kgf / 128,110 lb
Arm crowd force (ISO)	412 kN 42000 kgf / 92,590 lb	337 kN 34400 kgf / 75,840 lb	286 kN 29200 kgf / 64,375 lb	412 kN 42000 kgf / 92,590 lb



BACKHOE DIMENSIONS

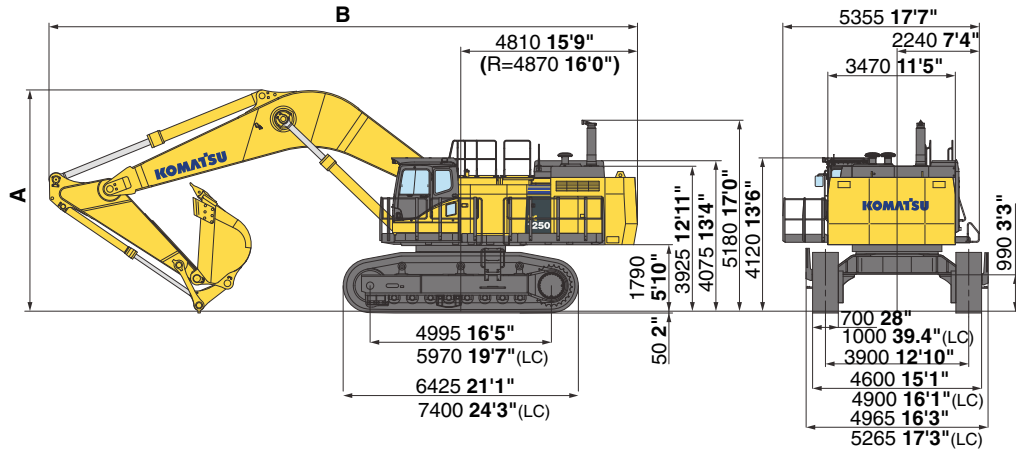

Unit: mm ft.in.

	PC1250-8/PC1250LC-8			PC1250SP-8
	9.1 m 29'10" boom			
	3.4 m 11'2" arm	4.5 m 14'9" arm	5.7 m 18'8" arm	7.8 m 25'7" boom
A Overall Height	6040 mm 19'10"	6460 mm 21'2"	6990 mm 22'11"	6265 mm 20'7"
B Overall Length	16020 mm 52'7"	16050 mm 52'8"	15840 mm 52'0"	14790 mm 48'6"



BACKHOE BUCKET, ARM, AND BOOM COMBINATION

BUCKET CAPACITY (HEAPED)				WIDTH				WEIGHT (with side cutters) kg lb	ARM LENGTH m ft in			
SAE, PCSA m ³ yd ³		CECE m ³ yd ³		Without Side cutters or shrouds mm in		With Side cutters or shrouds mm in			3.4 11'2"	4.5 14'9"	5.7 18'8"	
PC1250LC-8/ PC1250-8 (use with 9.1 m 29'10" boom)								3.4 11'2"	4.5 14'9"	5.7 18'8"		
3.4	4.4	3.0	3.9	1500	59"	1670	65.7"	3600	7,940	—	○	□
4.0	5.2	3.5	4.6	1710	67.3"	1880	74"	3800	8,380	○	□	▲
5.0	6.5	4.3	5.6	2050	80.7"	2220	87.4"	4400	9,700	□	▲	—
5.2	6.8	4.5	5.9	2050	80.7"	2110	83.1"	5100	11,240	□	▲	—
PC1250SP-8 (use with 7.8 m 25'7" boom)								3.4 11'2"	—	—		
6.7	8.8	5.9	7.7	2280	69.8"	2340	92.1"	6300	13,890	□	—	—

These charts are based on over-side stability with fully loaded bucket at maximum reach.

○: General purpose use, density up to 2.1 t/m³ 3,500 lb/yd³

□: General purpose use, density up to 1.8 t/m³ 3,000 lb/yd³

▲: General purpose use, density up to 1.5 t/m³ 2,500 lb/yd³

—: Not useable

PC1250LC-8 HYDRAULIC EXCAVATOR



LIFTING CAPACITY

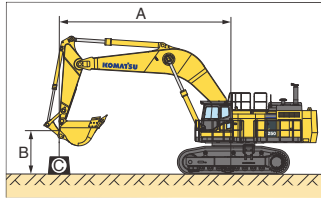

PC1250LC-8

Equipment:

- Boom: 9.1 m 29'10"
- Arm: 3.4 m 11'2"
- Bucket: 5.0 m³ 6.5 yd³
- Bucket weight: 4580 kg 10,097 lb
- Track shoe width: 1000 mm 39.4"
- 10-roller track frame
- Heavy lift mode "on"

- A: Reach from swing center
- B: Bucket hook height
- C: Lifting capacity
- Cf: Rating over front
- Cs: Rating over side
- ☉: Rating at maximum reach

Unit: kg lb

B \ A	☉ Maximum		12.2 m 40'		10.7 m 35'		9.1 m 30'		7.6 m 25'		6.1 m 20'		4.6 m 15'	
	Cf	Cs	Cf	Cs	Cf	Cs	Cf	Cs	Cf	Cs	Cf	Cs	Cf	Cs
9.1 m 30'	*15200 *33,500	*15200 *33,500			*18000 *39,700	*18000 *39,700								
6.1 m 20'	*15950 *35,100	14100 31,100			*20050 *44,200	18500 40,800	*22950 *50,600	22950 50,600	*27900 *61,500	*27900 *61,500				
3.0 m 10'	*18300 *40,300	12750 28,100	19950 43,900	13400 29,600	*22900 *50,500	17200 37,900	*27500 *60,600	22200 48,900	*34950 *77,100	29350 64,700				
0.0 m 0'	*21000 *46,300	13250 29,200			*24600 *54,200	16300 35,900	*28550 *63,000	19550 43,100	*37400 *82,400	27750 61,200				
-3.0 m -10'	*22700 *50,100	16300 36,000			*22800 *50,200	16350 36,100	*28550 *62,900	20850 46,000	*35300 *77,800	27950 61,700	*43850 *96,700	40750 89,900	*39250 *86,600	*39250 *86,600
-6.1 m -20'	*23500 *51,800	*23500 *51,800							*25400 *56,100	*25400 *56,100	*32550 *71,800	*32550 *71,800		

* Load is limited by hydraulic capacity rather than tipping. Ratings are based on SAE standard No. J/ISO10567. Rated loads do not exceed 87% of hydraulic lift capacity or 75% of tipping load.

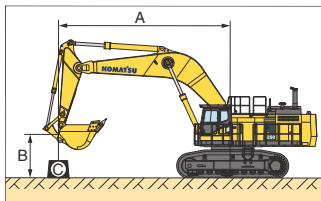

PC1250LC-8

Equipment:

- Boom: 9.1 m 29'10"
- Arm: 3.4 m 11'2"
- Bucket: 5.0 m³ 6.5 yd³
- Bucket weight: 4580 kg 10,097 lb
- Track shoe width: 1200 mm 47.2"
- 10-roller track frame
- Heavy lift mode "on"

- A: Reach from swing center
- B: Bucket hook height
- C: Lifting capacity
- Cf: Rating over front
- Cs: Rating over side
- ☉: Rating at maximum reach

Unit: kg lb

B \ A	☉ Maximum		12.2 m 40'		10.7 m 35'		9.1 m 30'		7.6 m 25'		6.1 m 20'		4.6 m 15'	
	Cf	Cs	Cf	Cs	Cf	Cs	Cf	Cs	Cf	Cs	Cf	Cs	Cf	Cs
9.1 m 30'	*15200 *33,500	*15200 *33,500			*18000 *39,700	*18000 *39,700								
6.1 m 20'	*15950 *35,100	14350 31,700			*20050 *44,200	18800 41,400	*22950 *50,600	*22950 *50,600	*27900 *61,500	*27900 *61,500				
3.0 m 10'	*18300 *40,300	13000 28,700	*19950 *43,900	13650 30,100	*22900 *50,500	17450 38,500	*27500 *60,600	22550 49,700	*34950 *77,100	29750 65,600				
0.0 m 0'	*21000 *46,300	13500 29,800			*24600 *54,200	16550 36,500	*28550 *63,000	19900 43,900	*37400 *82,400	28200 62,200				
-3.0 m -10'	*22700 *50,100	16600 36,600			*22800 *50,200	16650 36,700	*28550 *62,900	21200 46,700	*35300 *77,800	28400 62,600	*43850 *96,700	41350 91,200	*39250 *86,600	*39250 *86,600
-6.1 m -20'	*23500 *51,800	*23500 *51,800							*25400 *56,100	*25400 *56,100	*32550 *71,800	*32550 *71,800		

* Load is limited by hydraulic capacity rather than tipping. Ratings are based on SAE standard No. J/ISO10567. Rated loads do not exceed 87% of hydraulic lift capacity or 75% of tipping load.

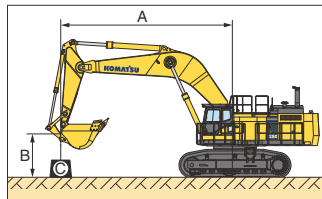

PC1250LC-8

Equipment:

- Boom: 9.1 m 29'10"
- Arm: 4.5 m 14'9"
- Bucket: 4.0 m³ 5.2 yd³
- Bucket weight: 4042 kg 8,911 lb
- Track shoe width: 1000 mm 39.4"
- 10-roller track frame
- Heavy lift mode "on"

- A: Reach from swing center
- B: Bucket hook height
- C: Lifting capacity
- Cf: Rating over front
- Cs: Rating over side
- ☉: Rating at maximum reach

Unit: kg lb

B \ A	☉ Maximum		12.2 m 40'		10.7 m 35'		9.1 m 30'		7.6 m 25'		6.1 m 20'		4.6 m 15'	
	Cf	Cs	Cf	Cs	Cf	Cs	Cf	Cs	Cf	Cs	Cf	Cs	Cf	Cs
9.1 m 30'	*9300 *20,500	*9300 *20,500												
6.1 m 20'	*9650 *21,300	*9650 *21,300	*16650 *36,700	14600 32,200	*18150 *40,000	*18150 *40,000	*20550 *45,400	*20550 *45,400						
3.0 m 10'	*10950 *24,200	*10950 *24,200	*18700 *41,300	13650 30,100	*21450 *47,300	17450 38,500	*25600 *56,500	22650 49,900	*32350 *71,400	30200 66,600				
0.0 m 0'	*13650 *30,100	11250 24,800	*20250 *44,700	12900 28,400	*23900 *52,600	16250 35,800	*28000 *61,700	19850 43,800	*36600 *80,700	27800 61,300	*29300 *64,600	*29300 *64,600		
-3.0 m -10'	20150 44,400	13350 29,400			*23850 *52,600	15900 35,000	*29200 *64,400	20400 45,000	*36300 *80,100	27400 60,400	*46350 *102,200	39800 87,800	*31900 *70,300	*31900 *70,300
-6.1 m -20'	*21750 *48,000	19950 44,000					*23650 *52,100	21300 47,000	*28850 *63,600	26850 59,200	*38200 *84,300	*38200 *84,300	*48,900 *107,800	*48,900 *107,800

* Load is limited by hydraulic capacity rather than tipping. Ratings are based on SAE standard No. J/ISO10567. Rated loads do not exceed 87% of hydraulic lift capacity or 75% of tipping load.

HYDRAULIC EXCAVATOR

PC1250LC-8



LIFTING CAPACITY

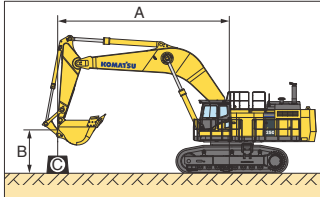

PC1250LC-8

Equipment:

- Boom: 9.1 m 29'10"
- Arm: 4.5 m 14'9"
- Bucket: 4.0 m³ 5.2 yd³
- Bucket weight: 4042 kg 8,911 lb
- Track shoe width: 1200 mm 47.2"
- 10-roller track frame
- Heavy lift mode "on"

- A: Reach from swing center
- B: Bucket hook height
- C: Lifting capacity
- Cf: Rating over front
- Cs: Rating over side
- ☉: Rating at maximum reach

Unit: kg lb

B \ A	☉ Maximum		12.2 m 40'		10.7 m 35'		9.1 m 30'		7.6 m 25'		6.1 m 20'		4.6 m 15'	
	Cf	Cs	Cf	Cs	Cf	Cs	Cf	Cs	Cf	Cs	Cf	Cs	Cf	Cs
9.1 m 30'	*9300 *20,500	*9300 *20,500												
6.1 m 20'	*9650 *21,300	*9650 *21,300	*16650 *36,700	14850 32,800	*18150 *40,000	*18150 *40,000	*20550 *45,400	*20550 *45,400						
3.0 m 10'	*10950 *24,200	*10950 *24,200	*18700 *41,300	13900 30,600	*21450 *47,300	17750 39,100	*25600 *56,500	23000 50,700	*32350 *71,400	30650 67,500				
0.0 m 0'	*13650 *30,100	11500 25,300	*20250 *44,700	13100 28,900	*23900 *52,600	16550 36,400	*28000 *61,700	20200 44,500	*36600 *80,700	28250 62,300	*29300 *64,600	*29300 *64,600		
-3.0 m -10'	*19400 *42,700	13600 30,000			*23850 *52,600	16150 35,700	*29200 *64,400	20750 45,700	*36300 *80,100	27800 61,300	*46350 *102,200	40450 89,100	*31900 *70,300	*31900 *70,300
-6.1 m -20'	*21750 *48,000	20300 44,700					*23650 *52,100	21650 47,800	*28850 *63,600	27300 60,200	*38200 *84,300	*38200 *84,300	48,900 *107,800	*48,900 *107,800

* Load is limited by hydraulic capacity rather than tipping. Ratings are based on SAE standard No. J/ISO10567. Rated loads do not exceed 87% of hydraulic lift capacity or 75% of tipping load.

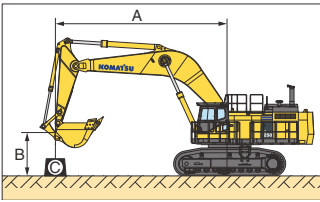

PC1250LC-8

Equipment:

- Boom: 9.1 m 29'10"
- Arm: 5.7 m 18'8"
- Bucket: 3.4 m³ 4.4 yd³
- Bucket weight: 3787 kg 8,349 lb
- Track shoe width: 1000 mm 39.4"
- 10-roller track frame
- Heavy lift mode "on"

- A: Reach from swing center
- B: Bucket hook height
- C: Lifting capacity
- Cf: Rating over front
- Cs: Rating over side
- ☉: Rating at maximum reach

Unit: kg lb

B \ A	☉ Maximum		12.2 m 40'		10.7 m 35'		9.1 m 30'		7.6 m 25'		6.1 m 20'		4.6 m 15'	
	Cf	Cs	Cf	Cs	Cf	Cs	Cf	Cs	Cf	Cs	Cf	Cs	Cf	Cs
9.1 m 30'	*5900 *13,000	*5900 *13,000												
6.1 m 20'	*6050 *13,400	*6050 *13,400	*14950 *32,900	*14950 *32,900										
3.0 m 10'	*6800 *15,000	*6800 *15,000	*17400 *38,300	14050 31,000	*19800 *43,700	17950 39,600	*23450 *51,700	23400 51,500	*29300 *64,600	*29300 *64,600	*39750 *87,600	*39750 *87,600		
0.0 m 0'	*8400 *18,500	*8400 *18,500	*19500 *43,000	13000 28,600	*22850 *50,400	16400 36,200	*27700 *61,100	21100 46,600	*35100 *77,400	28150 62,000	*31200 *68,800	*31200 *68,800		
-3.0 m -10'	*11500 *25,400	11,000 24,300	*20050 *44,200	12500 27,600	*24000 *63,000	15650 34,500	*29250 *64,500	20150 44,400	*36600 *80,700	27000 59,600	*47600 *104,900	39150 86,300	*26750 *59,000	*26750 *59,000
-6.1 m -20'	*19400 *42,800	15150 33,400			*21050 *46,500	16050 35,400	*26600 *58,700	20450 45,100	*33250 *73,300	27500 60,700	*42350 *93,300	40200 88,600	*47950 *105,700	*47950 *105,700

* Load is limited by hydraulic capacity rather than tipping. Ratings are based on SAE standard No. J/ISO10567. Rated loads do not exceed 87% of hydraulic lift capacity or 75% of tipping load.

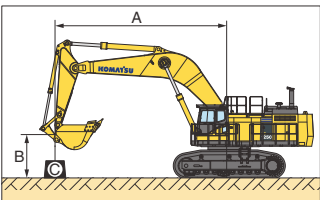

PC1250LC-8

Equipment:

- Boom: 9.1 m 29'10"
- Arm: 5.7 m 18'8"
- Bucket: 3.4 m³ 4.4 yd³
- Bucket weight: 3787 kg 8,349 lb
- Track shoe width: 1200 mm 47.2"
- 10-roller track frame
- Heavy lift mode "on"

- A: Reach from swing center
- B: Bucket hook height
- C: Lifting capacity
- Cf: Rating over front
- Cs: Rating over side
- ☉: Rating at maximum reach

Unit: kg lb

B \ A	☉ Maximum		12.2 m 40'		10.7 m 35'		9.1 m 30'		7.6 m 25'		6.1 m 20'		4.6 m 15'	
	Cf	Cs	Cf	Cs	Cf	Cs	Cf	Cs	Cf	Cs	Cf	Cs	Cf	Cs
9.1 m 30'	*5900 *13,000	*5900 *13,000												
6.1 m 20'	*6050 *13,400	*6050 *13,400	*14950 *32,900	*14950 *32,900										
3.0 m 10'	*6800 *15,000	*6800 *15,000	*17400 *38,300	14300 31,500	*19800 *43,700	18250 40,200	*23450 *51,700	*23450 *51,700	*29300 *64,600	*29300 *64,600	*39750 *87,600	*39750 *87,600		
0.0 m 0'	*8400 *18,500	*8400 *18,500	*19500 *43,000	13250 29,200	*22850 *50,400	16700 36,800	*27700 *61,100	21450 47,300	*35100 *77,400	28550 63,000	*31200 *68,800	*31200 *68,800		
-3.0 m -10'	*11500 *25,400	11250 24,800	*20050 *44,200	12750 28,100	*24000 *63,000	15950 35,200	*29250 *64,500	20500 45,200	*36600 *80,700	27450 60,500	*47600 *104,900	39750 87,600	*26750 *59,000	*26750 *59,000
-6.1 m -20'	*19200 *42,300	15400 34,000			*21050 *46,500	16350 36,100	*26600 *58,700	20800 45,900	*33250 *73,300	27950 61,600	*42350 *93,300	40800 89,900	*47950 *105,700	*47950 *105,700

* Load is limited by hydraulic capacity rather than tipping. Ratings are based on SAE standard No. J/ISO10567. Rated loads do not exceed 87% of hydraulic lift capacity or 75% of tipping load.

PC1250LC-8 HYDRAULIC EXCAVATOR



LIFTING CAPACITY

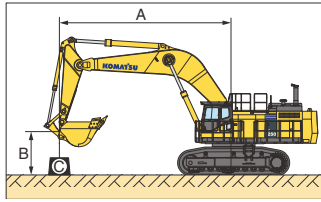

PC1250-8

Equipment:

- Boom: 9.1 m 29'10"
- Arm: 3.4 m 11'2"
- Bucket: 5.0 m³ 6.5 yd³
- Bucket weight: 4400 kg 9,700 lb
- Track shoe width: 700 mm 28"
- 8-roller track frame

- A: Reach from swing center
- B: Bucket hook height
- C: Lifting capacity
- Cf: Rating over front
- Cs: Rating over side
- ☉: Rating at maximum reach

Unit: kg lb

	A	☉ Maximum		12.2 m 40'		10.7 m 35'		9.1 m 30'		7.6 m 25'		6.1 m 20'		4.6 m 15'	
		Cf	Cs	Cf	Cs	Cf	Cs	Cf	Cs	Cf	Cs	Cf	Cs	Cf	Cs
Heavy Lift On	9.1 m 30'	*15200 *33,500	*15200 *33,500			*18000 *39,700	*18000 *39,700								
	6.1 m 20'	*15950 *35,100	13200 29,100			*20050 *44,200	17400 38,400	*22950 *50,600	*22950 *50,600	*27900 *61,500	*27900 *61,500				
	3.0 m 10'	15650 34,500	11850 26,200	16400 36,100	12500 27,500	20850 46,000	16100 35,500	27000 59,500	20850 46,000	*34950 *77,100	27650 60,900				
	0.0 m 0'	16250 35,900	12300 27,100			19950 44,000	15200 33,500	24200 53,400	18200 40,200	34400 75,800	26100 57,500				
	-3.0 m -10'	19950 44,000	15250 33,600			20000 44,100	15250 33,700	25600 56,400	19550 43,100	34600 76,300	26300 57,900	*43850 *96,700	38400 84,700	*39250 *86,600	*39250 *86,600
	-6.1 m -20'	*23500 *51,800	*23500 *51,800							*25400 *56,100	*25400 *56,100			*32550 *71,800	*32550 *71,800
	-9.1 m -30'														
Heavy Lift Off	9.1 m 30'	*15200 *33,500	*15200 *33,500			*15500 *34,200	*15500 *34,200								
	6.1 m 20'	*15850 *34,900	13200 29,100			*17300 *38,100	*17300 *38,100	*19950 *44,000	*19950 *44,000	*24400 *53,800	*24400 *53,800				
	3.0 m 10'	15650 34,500	11850 26,200	16400 36,100	12500 27,500	*19800 *43,700	16100 35,500	*23900 *52,700	20850 46,000	*30550 *67,400	27650 60,900				
	0.0 m 0'	16250 35,900	12300 27,100			19950 44,000	15200 33,500	24200 53,400	18200 40,200	*32650 *72,000	26100 57,500				
	-3.0 m -10'	*19600 *43,200	15250 33,600			*19650 *43,300	15250 33,700	*24750 *54,600	19550 43,100	*30750 *67,800	26300 57,900	*38350 *84,500	*38350 *84,500	*39250 *86,600	*39250 *86,600
	-6.1 m -20'	*20150 *44,500	*20150 *44,500							*21900 *48,200	*21900 *48,200			*28150 *62,100	*28150 *62,100
	-9.1 m -30'														

* Load is limited by hydraulic capacity rather than tipping. Ratings are based on SAE standard No. J/ISO10567. Rated loads do not exceed 87% of hydraulic lift capacity or 75% of tipping load.

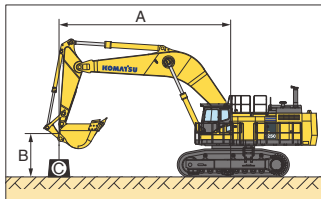

PC1250-8

Equipment:

- Boom: 9.1 m 29'10"
- Arm: 4.5 m 14'9"
- Bucket: 4.0 m³ 5.2 yd³
- Bucket weight: 3800 kg 8,380 lb
- Track shoe width: 700 mm 28"
- 8-roller track frame

- A: Reach from swing center
- B: Bucket hook height
- C: Lifting capacity
- Cf: Rating over front
- Cs: Rating over side
- ☉: Rating at maximum reach

Unit: kg lb

	A	☉ Maximum		12.2 m 40'		10.7 m 35'		9.1 m 30'		7.6 m 25'		6.1 m 20'		4.6 m 15'	
		Cf	Cs	Cf	Cs	Cf	Cs	Cf	Cs	Cf	Cs	Cf	Cs	Cf	Cs
Heavy Lift On	9.1 m 30'	*9300 *20,500	*9300 *20,500												
	6.1 m 20'	*9650 *21,300	*9650 *21,300	*16650 *36,700	13700 30,200	*18150 *40,000	18000 39,700	*20550 *45,400	*20550 *45,400						
	3.0 m 10'	*10950 *24,200	10200 22,500	16650 36,700	12750 28,100	21200 46,700	16400 36,100	*25600 *56,500	21300 47,000	*32350 *71,400	28500 62,800				
	0.0 m 0'	*13650 *30,100	10400 23,000	15850 34,900	11950 26,400	19900 43,900	15150 33,400	24550 54,100	18500 40,800	34,450 75,900	26100 57,600	*29300 *64,600	*29300 *64,600		
	-3.0 m -10'	16400 36,200	12400 27,300			19550 43,100	14800 32,600	25100 55,400	19050 42,000	34000 75,000	25700 56,600	*46350 *102,200	37500 82,600	*31900 *70,300	*31900 *70,300
	-6.1 m -20'	*21750 *48,000	18700 41,300					*23650 *52,100	20000 44,100	*28850 *63,600	25200 55,500	*38200 *84,300	*38200 *84,300	*48900 *107,800	*48900 *107,800
	-9.1 m -30'														
Heavy Lift Off	9.1 m 30'	*9300 *20,500	*9300 *20,500												
	6.1 m 20'	*9650 *21,300	*9650 *21,300	*14250 *31,400	13700 30,200	*15600 *34,400	*15600 *34,400	*17850 *39,300	*17850 *39,300						
	3.0 m 10'	*10950 *24,200	10200 22,500	*16050 *35,400	12750 28,100	*18500 *40,800	16400 36,100	*22250 *49,000	21300 47,000	*28250 *62,300	*28250 *62,300				
	0.0 m 0'	*13650 *30,100	10400 23,000	15850 34,900	11950 26,400	19900 43,900	15150 33,400	24200 53,300	18500 40,800	*31950 *70,400	26100 57,600	*29300 *64,600	*29300 *64,600		
	-3.0 m -10'	16400 36,200	12400 27,300			19550 43,100	14800 32,600	25100 55,400	19050 42,000	*31650 *69,800	25700 56,600	*40550 *89,400	37500 82,600	*31900 *70,300	*31900 *70,300
	-6.1 m -20'	*18650 *41,100	18650 41,100					*20300 *44,800	20000 44,100	*24800 *54,700	24800 54,700	*33200 *73,200	*33200 *73,200	*42600 *93,900	*42600 *93,900
	-9.1 m -30'														

* Load is limited by hydraulic capacity rather than tipping. Ratings are based on SAE standard No. J/ISO10567. Rated loads do not exceed 87% of hydraulic lift capacity or 75% of tipping load.



LIFTING CAPACITY

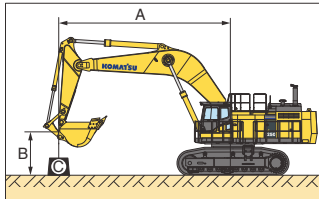

PC1250-8

Equipment:

- Boom: 9.1 m 29'10"
- Arm: 5.7 m 18'8"
- Bucket: 3.4 m³ 4.4 yd³
- Bucket weight: 3600 kg 7,940 lb
- Track shoe width: 700 mm 28"
- 8-roller track frame

- A: Reach from swing center
- B: Bucket hook height
- C: Lifting capacity
- Cf: Rating over front
- Cs: Rating over side
- ⊗: Rating at maximum reach

Unit: kg lb

	A \ B	⊗ Maximum		13.7 m 45'		12.2 m 40'		10.7 m 35'		9.1 m 30'		7.6 m 25'		6.1 m 20'	
		Cf	Cs	Cf	Cs	Cf	Cs	Cf	Cs	Cf	Cs	Cf	Cs	Cf	Cs
Heavy Lift On	9.1 m 30'	*5900 *13,000	*5900 *13,000												
	6.1 m 20'	*6050 *13,400	*6050 *13,400	*11050 *24,300	10950 24,100	*14950 *32,900	14350 31,600								
	3.0 m 10'	*6800 *15,000	*6800 *15,000	13550 29,900	10250 22,600	17050 37,600	13100 28,900	*19800 *43,700	16900 37,200	*23450 *51,700	22050 48,600	*29300 *64,600	*29300 *64,600	*39750 *87,600	*39750 *87,600
	0.0 m 0'	*8400 *18,500	*8400 *18,500	12850 28,400	9600 21,100	15950 35,200	12050 26,600	20,100 44,300	15300 33,800	25900 57,100	19800 43,600	34800 76,700	26450 58,300	*31200 *68,800	*31200 *68,800
	-3.0 m -10'	*11500 *25,400	10150 22,400			15500 34,100	11600 25,600	19300 42,600	14600 32,100	24850 54,800	18800 41,500	33600 74,100	25300 55,800	*47600 *105,000	36800 81,100
	-6.1 m -20'	18600 41,000	14100 31,100					19750 43,500	15000 33,000	25200 55,600	19150 42,200	*33250 *73,300	25850 56,900	*42350 *93,300	37850 83,400
Heavy Lift Off	9.1 m 30'	*5900 *13000	*5900 *13000												
	6.1 m 20'	*6050 *13,400	*6050 *13,400	*11050 *24,300	10950 24,100	*12700 *28,000	*12700 *28,000								
	3.0 m 10'	*6800 *15,000	*6800 *15,000	*13350 *29,500	10250 22,600	*14850 *32,800	13100 28,900	*17050 *37,600	16900 37,200	*20300 *44,800	*20300 *44,800	*25550 *56,300	*25550 *56,300	*34850 *76,800	*34850 *76,800
	0.0 m 0'	*8400 *18,500	*8400 *18,500	12850 28,400	9600 21,100	15950 35,200	12050 26,600	*19700 *43,400	15300 33,800	*24000 *53,000	19800 43,600	*30600 *67,500	26450 58,300	*31200 *68,800	*31200 *68,800
	-3.0 m -10'	*11500 *25,400	10150 22,400			15500 34,100	11600 25,600	19300 42,600	14600 32,100	24850 54,800	18800 41,500	*31900 *70,300	25300 55,800	*41650 *91,800	36600 81,100
	-6.1 m -20'	*16550 *36,500	14100 31,100					*18050 *39,800	15000 33,000	*22950 *50,600	19150 42,200	*28850 *63,600	25850 56,900	*36900 *81,300	*36900 *81,300

* Load is limited by hydraulic capacity rather than tipping. Ratings are based on SAE standard No. J/ISO10567. Rated loads do not exceed 87% of hydraulic lift capacity or 75% of tipping load.

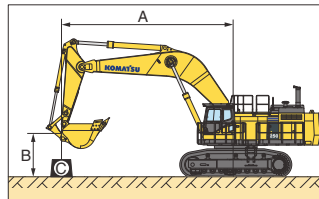

PC1250SP-8

Equipment:

- Boom: 7.8 m 25'7"
- Arm: 3.4 m 11'2"
- Bucket: 6.7 m³ 8.8 yd³
- Bucket weight: 6300 kg 13,890 lb
- Track shoe width: 700 mm 28"
- 8-roller track frame

- A: Reach from swing center
- B: Bucket hook height
- C: Lifting capacity
- Cf: Rating over front
- Cs: Rating over side
- ⊗: Rating at maximum reach

Unit: kg lb

	A \ B	⊗ Maximum		12.2 m 40'		10.7 m 35'		9.1 m 30'		7.6 m 25'		6.1 m 20'		4.6 m 15'	
		Cf	Cs	Cf	Cs	Cf	Cs	Cf	Cs	Cf	Cs	Cf	Cs	Cf	Cs
Heavy Lift On	9.1 m 30'	*11700 *25,800	*11700 *25,800					*17050 *37,600	*17050 *37,600						
	6.1 m 20'	*12250 *27,000	*12250 *27,000			*16300 *35,900	16100 35,600	*24350 *53,700	22600 49,800	*28750 *63,400	*28750 *63,400	*36350 *80,100	*36350 *80,100		
	3.0 m 10'	*14600 *32,200	13700 30,200			20150 44,400	15300 33,800	26950 59,500	20750 45,700	*33850 *74,700	27000 59,600	*47450 *104,600	41150 90,700		
	0.0 m 0'	19300 42,600	14550 32,000			19400 42,800	14600 32,200	25600 56,400	19450 42,900	31750 70,000	23500 51,800	*48750 *107,500	38650 85,200		
	-3.0 m -10'	*23900 *52,700	19550 43,100					*23950 *52,900	19550 43,100	*30750 *67,800	24850 54,800	*41450 *91,300	39,250 86,500	*52450 *115,700	*52450 *115,700
	-6.1 m -20'														
Heavy Lift Off	9.1 m 30'	*11700 *25,800	*11700 *25,800					*17050 *37,600	*17050 *37,600						
	6.1 m 20'	*12250 *27,000	*12250 *27,000			*16300 *35,900	16100 35,600	*21150 *46,600	*21150 *46,600	*25150 *55,500	*25150 *55,500	*32100 *70,800	*32100 *70,800		
	3.0 m 10'	*14600 *32,200	13700 30,200			20150 44,400	15300 33,800	*24450 *54,000	20750 45,700	*29450 *65,000	27000 59,600	*41750 *92,000	41150 90,700		
	0.0 m 0'	19300 42,600	14550 32,000			19400 42,800	14600 32,200	25600 56,400	19450 42,900	*29900 *65,900	23500 51,800	*42750 *94,300	38650 85,200		
	-3.0 m -10'	*20500 *45,200	19550 43,100					*20550 *45,300	19550 43,100	*26450 *58,300	24850 54,800	*36100 *79,600	*36100 *79,600	*45800 100,800	*45800 100,800
	-6.1 m -20'														

* Load is limited by hydraulic capacity rather than tipping. Ratings are based on SAE standard No. J/ISO10567. Rated loads do not exceed 87% of hydraulic lift capacity or 75% of tipping load.

PC1250LC-8 HYDRAULIC EXCAVATOR

TRANSPORTATION GUIDE



TRANSPORTATION GUIDE

Transportation volume (length x height x width)

Specs shown include the following equipment:

Backhoe: Boom 9100 mm **29'10"**, Arm 3400 mm **11'2"**, Bucket 5.0 m³ **6.5 yd³**, Shoes 700 mm **28"** double grouser

Work equipment assembly (Backhoe)

Weight : PC1250 : 25.3 t **27.9 U.S.ton**
 PC1250SP : 27.7 t **30.5 U.S.ton**

Boom



PC1250 : 11.2 t : 9475 x 2894 x 1474
12.3 U.S.ton : 31'1" x 9'6" x 4'10"
 PC1250SP : 11.1 t : 8170 x 3095 x 1474
12.2 U.S.ton : 26'10" x 10'2" x 4'10"

Arm

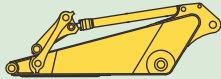

PC1250 : 5.9 t : 4895 x 1626 x 890
6.5 U.S.ton : 16'1" x 5'4" x 2'11"
 PC1250SP : 6.4 t : 4914 x 1683 x 890
7.1 U.S.ton : 16'1" x 5'6" x 2'11"

Bucket (Typical)

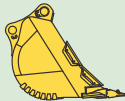

PC1250 : 4.3 t : 2700 x 2100 x 2050
4.7 U.S.ton : 8'10" x 6'11" x 6'9"
 PC1250SP : 6.3 t : 2527 x 2420 x 2520
6.9 U.S.ton : 8'3" x 7'11" x 8'3"

Arm cylinder



Length : 3950 **13'0"**

1.5 t
1.7 U.S.ton

Boom cylinder

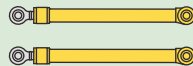

Length: 3810 **12'6"**

2.4 t [1.2 t x 2]
2.64 U.S.ton [1.32 U.S.ton x 2]

Upper structure

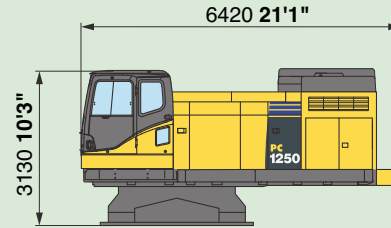

Width : 3490 **11'5"**
 Weight : 36.4 t **40.1 U.S.ton**

Undercarriage (8-roller)

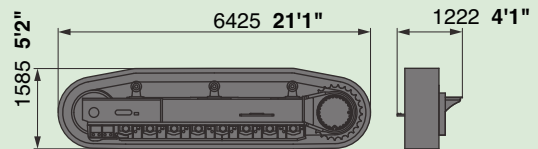

Weight : 30 t [15 t x 2]
33.1 U.S.ton [16.55 U.S.ton x 2]
 Weight : 30.9 t [15.45 t x 2] (with full length roller guard)
34.1 U.S.ton [17.05 U.S.ton x 2]

Others

Weight : 18.4 t **20.3 U.S.ton**

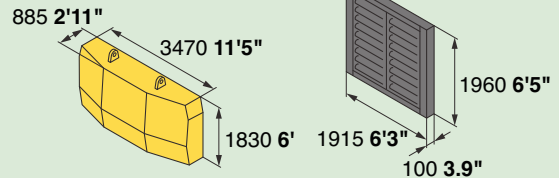

Weight : 18.0 t **19.8 U.S.ton**

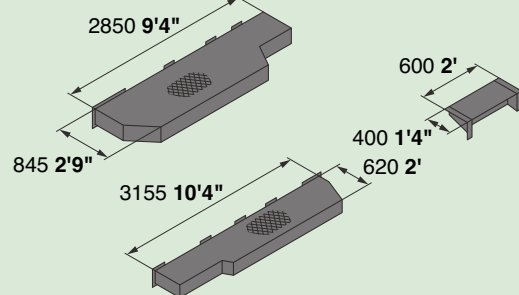



STANDARD EQUIPMENT

ENGINE AND RELATED ITEMS:

- Air cleaner, double element, dry type
- Auto decelerator
- Electric fuel priming pump
- Engine, Komatsu SAA6D170E-5
- Fuel pre-filters (10 micron) with water separator
- Fuel primary filter (2 micron)
- Variable speed cooling fan, hydraulic drive, reversible

ELECTRICAL SYSTEM:

- Alternator, 90 amp, 24 V
- Batteries, 220 Ah, 2 x 12 V
- Interconnected horn and flashing light
- Power supply, 12V
- Starting motors, 11kW x 2
- Step light with timer
- Working lights-2 boom, 2 cab top front, 1 cab bottom

UNDERCARRIAGE:

- 700 mm **28"** double grouser (PC1250-8)
- 1000 mm **39.4"** double grouser (PC1250LC-8)
- 8 track/3 carrier rollers (each side)(PC1250-8)
- 10 track/3 carrier rollers (each side)(PC1250LC-8)
- Hydraulic track adjusters (each side)
- Track guiding guard (each side)

GUARDS AND COVERS:

- Engine thermal guards and fan guard
- Dust-proof net for radiator and oil cooler
- Pump/engine room partition wall
- Travel motor guards
- Revolving frame under cover (Heavy-duty)
- Track frame undercover (center)

OPERATOR ENVIRONMENT:

- Damper mount, all-weather, pressurized, sound-suppressed cab with tinted glass windows, lockable door, intermittent window wiper and washer, floor mat, cigarette lighter and ashtray
- Instrument panel with electronic display/monitor system, electronically-controlled throttle dial, electric service meter, gauges (coolant temperature, hydraulic temperature and fuel level), caution lights (electric charge, engine oil pressure, and air cleaner clogging), indicator lights (engine preheating and swing lock light) level check lights (coolant, engine oil, and hydraulic oil level), self-diagnostic system with trouble data memory
- Automatic air conditioner/heater/defroster system
- FOPS
- Pull-up type front window, lockable

- Radio, AM-FM
- Rearview mirrors, left and right
- Seat, fully adjustable with suspension
- Seat belt 78 mm **3"** non-cinching

HYDRAULIC CONTROLS:

- Fully hydraulic, with Electronic Open-Center Load-Sensing (EOLSS) and engine speed sensing (pump and engine mutual control system)
- One gear pump for control circuit
- Two axial piston motors for swing with single-stage relief valve
- One axial piston motor per track for travel with counter balance valve
- Three variable capacity piston pumps (2 Main, 1 Swing)
- Three control valves, 5+4+4 spools (boom, arm, bucket, swing, and travel)
- Control levers, wrist control levers for arm, boom, bucket, and swing with PPC system
- Control levers and pedals for steering and travel with PPC system
- Oil cooler, hydraulic
- In-line high pressure hydraulic filters
- Shockless boom control
- Swing priority mode
- Two-mode setting for boom
- Working modes: Power, Economy (four level), Heavy Lift

DRIVE AND BRAKE SYSTEM:

- Brakes, hydraulic lock travel brakes, oil disc parking
- Hydrostatic two travel speed system with planetary double reduction final drive

OTHER STANDARD EQUIPMENT:

- Automatic swing holding brake
- Corrosion resister
- Counterweight, 18000 kg **39,680 lb**
- Grease gun, air pump type
- Horn, air
- KOMTRAX Plus
- Large handrails and steps
- Lift capacity chart
- Marks and plates, English
- One-touch engine oil drainage
- Paint, Komatsu standard
- PM tune-up service connector
- Slip resistant plates
- Travel alarm
- Wide catwalk



OPTIONAL EQUIPMENT

- Arms (Backhoe):
 - 3400 mm **11'2"** arm assembly
 - 3400 mm **11'2"** SP arm assembly (PC1250-8)
 - 4500 mm **14'9"** arm assembly
 - 5700 mm **18'8"** arm assembly
- Booms (Backhoe):
 - 7800 mm **25'7"** SP boom assembly (PC1250-8)
 - 9100 mm **29'10"** boom assembly
- Cab full front guard (PC1250-8)
- Shoes:
 - 1000 mm **39.4"** double grouser (PC1250-8)
 - 1200 mm **47.25"** double grouser (PC1250LC-8)
- Track roller guard (full length) (PC1250-8)



AESS698-02

©2012 Komatsu Printed in USA

AD04(5M)C

04/12 (EV-1)

KOMATSU[®]

www.KomatsuAmerica.com

Komatsu America Corp. is an authorized licensee of Komatsu Ltd. Materials and specifications are subject to change without notice. **KOMATSU** is a registered trademark of Komatsu Ltd., Japan. KOMTRAX Plus is a trademark of Komatsu America Corp.