

MODEL SPECIFICATIONS

	UP 15SV	UP 20SV	UP 25SV	UP 30SV	UP 45SV	UP 75SV
2ND Member Exc. Wt.	N/A	22,000 Lb. (10M Tons)	30,000 Lb. (14M Tons)	44,000 Lb. (20M Tons)	55,000 Lb. (25 M Tons)	80,000 Lb. (30M Tons)
3RD Member Exc. Wt.	33,000 Lb. (15 M tons)	44,000 Lb. (20 M Tons)	55,000 Lb. (25 M Tons)	66,000 Lb. (30M Tons)	99,000 Lb. (45 M Tons)	135,000 Lb. (61M Tons)
Wt. W/ Jaw Set Installed	3,900 Lb. (1773 Kg.)	4,500 Lb. (2045 Kg.)	5,600 Lb. (2545 Kg.)	7,800 (3,545 Kg.)	10,500 Lb. (4775 Kg.)	12,650 (5750 Kg.)
Shear Jaw Opening	14" (355mm)	18" (457mm)	21" (533mm)	25" (635mm)	26" (660mm)	33" (838mm)
Shear Jaw Depth	14" (355mm)	18" (457mm)	22" (559mm)	25" (635mm)	28" (711mm)	34" (864mm)
CC Jaw Opening	25" (635mm)	29" (737mm)	33" (838mm)	41" (1,041mm)	45" (1143mm)	49" (1245mm)
CC Jaw Depth	22" (559mm)	25" (635mm)	26" (660mm)	30" (762mm)	34" (864mm)	36" (914mm)
CP Jaw Opening	Not Available	24" (610mm)	28" (711mm)	32" (813mm)	36" (914mm)	40" (1016mm)
CP Jaw Depth	Not Available	21" (533mm)	22" (559mm)	26" (660mm)	27 (686mm)	30" (762mm)
PS Jaw Opening	Not Available	13.5" (343mm)	15" (381mm)	16" (406mm)	Not Available	Not Available
PS Jaw Depth	Not Available	12" (305mm)	15" (381mm)	18" (457mm)	Not Available	Not Available
Approx. Reach	6' 2" (1880mm)	7' 0" (2,100mm)	8' 0" (2,438mm)	8' 8" (2,642mm)	9' 9" (2972mm)	11' 5" (3556mm)

The **LaBounty Universal Processors SV** series are ideal for demolition, road and bridge reconstruction and recycling operations. They offer the end-user incredible versatility through the means of interchangeable jaws, ensuring the right tool for the right application. Key features include:

- **Interchangeable Jaws** sets for maximum productivity in various applications. Up to 4 jaw sets currently offered including: Shear (SH), Concrete Pulverizer (CP), Concrete Cracking (CC) and Plate Shear (PS) -see reverse side.
- **360° Powered Rotation** – Allows for efficient processing at virtually any angle.
- **Time Tested, Spool Type Speed Valve** for fast cycle times.
- **2 large bore cylinders** along with long lever arms generate the highest power to weight ratio per model as compared to single cylinder attachments. The two-cylinder design evens out the power curve, producing maximum power throughout the closing cycle.
- **Slotted Pivot** for much faster and easier jaw change out. A slot has been added to the UP's main pivot point, which allows much faster and easier jaw line up than before. Most jaw sets can be changed out in as little as 20 minutes or less.
- **Reverse, shrouded cylinders** – The cylinder barrel moves back and forth, keeping the cylinder rods away from the material. The heavy-duty shrouds provide added protection.

- **Multiple Machine Mount Capability** – Multi-machine head / lugs come standard with the UP SV series, allowing them to be mounted to other machines through the use of a pin and bushing kit (please call factory to verify mounting options).

UP SV UNIVERSAL PROCESSOR COMPONENTS

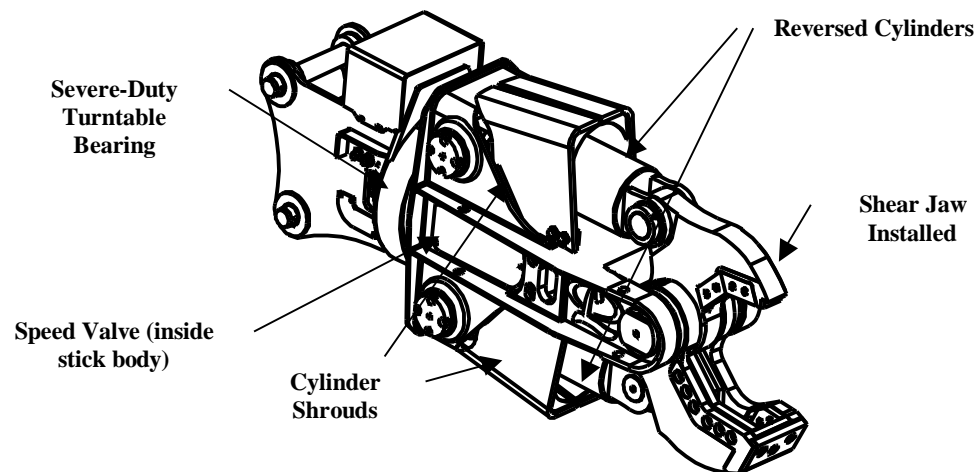

ACCESSORIES

Internal Hydraulic Rotation Kit (factory installed inside rotation head)

Note: not available for UP 15SV

External Hydraulic Rotation Kit (installed onto base machine)

Hanging Lugs (for hanging from cable crane)

Swift Lock Pin-On Replaceable Teeth and Indexable Cutting Blades

At-Factory Upgrade and Rebuilding Services

UP SV Series Concrete Cracking (CC) Jaw

Breaks large, oversized concrete (abutments, beams, etc.). Ideal for primary demolition applications. High grade, abrasion resistant steel used in entire jaw. Improved Swift Lock teeth for quick changeover and reduced downtime. Rebar cutting blades in throat.

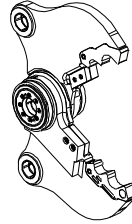

UP SV Series Concrete Pulverizer (CP) Jaw

Excellent for crushing concrete and separating out rebar. Improved Swift Lock teeth allow for quick changeover and reduced downtime. High grade, abrasion resistant steel used in entire jaw. Rebar cutting blades in throat.

NOTE: CP jaw not available for UP 15SV

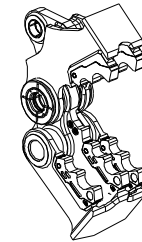

UP SV Series Shear (SH) Jaw

Cuts rebar and structural steel such as I-beams, H-beams, pipe, etc. Improved pivot components for longer life and patented cutting blade system ensure better performance and reduced maintenance.

NOTE: UP 15SV Shear Jaw does not contain nose blade

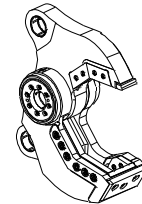

UP SV Series Plate Shear (PS) Jaw

Designed for cutting above and below ground storage tanks. "Beak" on upper jaw for tearing thinner plate and initiating starter hole. Leaves plate flat versus conventional shear.

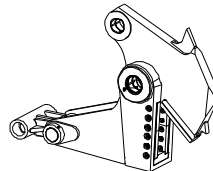

Easy Jaw Change-Out

- The attached diagram illustrates the ease to which jaws can be changed out (in as little as 20 minutes). This ensures the right tool for the right job.

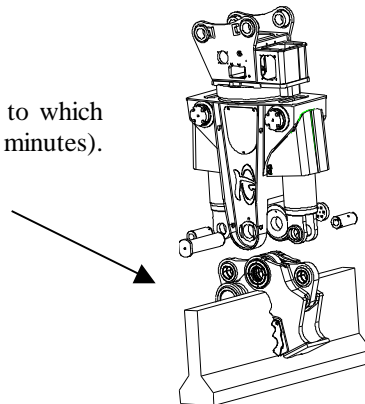

Clip Ring

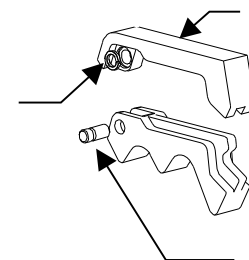

Tooth seat is welded into the attachment frame.

One pin locks the tooth into the seat.

WARRANTY

Stanley Hydraulic Tools and their associated parts are warranted against defects in materials and workmanship for a period of twelve months or 1500 hours from the date of purchase. Stanley Hydraulic Tools reserves the right to repair or replace only those parts, which prove to have been defective at the time of purchase. This warranty becomes void if maximum flow and pressure ratings are exceeded.

OPTIONS / FEATURES

The "universal bracket", standard with UP models 15, 20, 30 and 45, manufactured for 3rd member installation, allow mounting to a variety of base machines in the same weight class with similar operating pressures. An additional mounting kit (bushing, spacer and pins) available from LaBounty may be required to complete installation to other compatible machines.

3rd member to 2nd member adapter brackets are also available. Typically, when changing from 3rd to 2nd member, the base machine may drop 2 classes in size. All such conversions must be approved by Stanley LaBounty prior to sale.

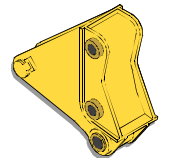

3rd Member to 2nd Member Adapter Bracket

Swift Lock Teeth are available for all CC and CP Jaws with the exception of the UP 75CC Jaw.